



## **OperatiRead this manual carefully before installing, operating, servicing or repairing.traction for Air Impact Wrench**

### **Working environment:**

- 1.Using these tools in any potentially explosive environment is strictly prohibited.
- 2.It is always recommended that these types of tools must be operated when standing on a solid or firm location.
- 3.Always use these tools in a well ventilated area.
- 4.Slipping, stumbling and falling are the major causes of potential serious injury, therefore, a clean and clutter free surface in the working area before operating the tools is strongly recommended.

### **Air supply and connection requirements:**

- 1.The maximum recommended air pressure during operation must not exceed 90 psi (6.3bar). Higher air pressure may create unsafe operating conditions for the tool and the user.
- 2.The compressed air should be cooled and have a water filter installed at the outlet end of the compressor. Even with a water filter installed, some water may still condense in the piping or hose and will enter the tool mechanism causing premature damage to the tool. Therefore, it is recommended to install an air filter-lubricator device somewhere between the tool and the compressor.
- 3.Always use an air compressor of the proper capacity to operate each tool.
- 4.Clean the hose with a blast of compressed air before connecting the hose to the air tool. This will prevent both moisture and dust inside the hose from entering the tool and causing possible rust or malfunction.



## Ideal system connection:

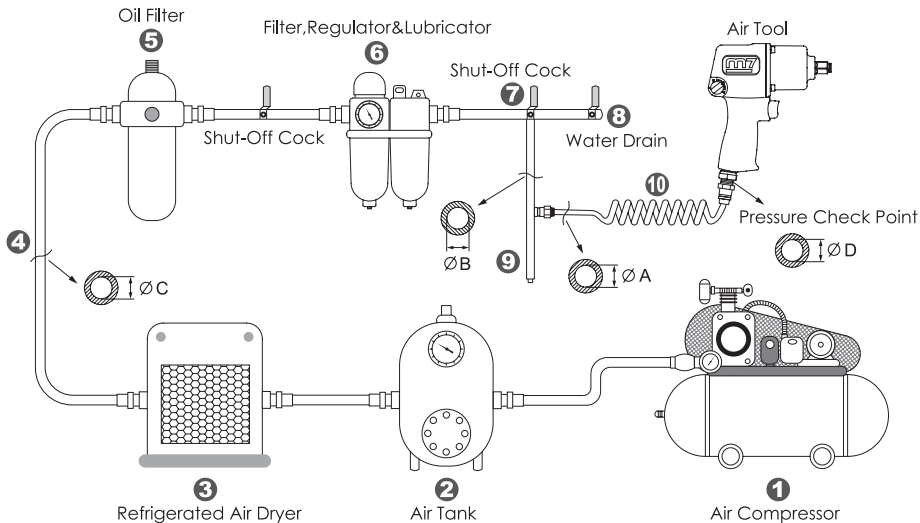

## Piping diameters and length requirement:

- ★The diameter  $\Phi A$  required for the inlet pipe (10) is recommended on the specification table.
- ★The diameter  $\Phi B$  required for the branch pipe (from 7 to 9) should be 2 times as large as  $\Phi A$ .  
 $\Phi B = 2 \times \Phi A$
- ★The diameter  $\Phi C$  required for the primary air supply (from 1 to 8) should be 3 times as large as  $\Phi A$ .  
 $\Phi C = 3 \times \Phi A$
- ★The length for the inlet pipe (10) should be less than 15 feet (4.5m).



**! Warning: !**

1. This tool should only be used as a hand operated tool. It is powered by compressed air and is not insulated against electric shock.
2. This tool is specially designed for tightening or loosening bolts or nuts. Any application or use of this tool other than what it is designed for is strictly prohibited.
3. Use only pneumatic impact sockets and accessories on this tool. Never use hand sockets or accessories.
4. High sound levels may cause hearing damage. Always wear hearing protection when operating this tool.
5. Wearing eye/face protection can reduce the danger of high-speed socket being ejected from the tool, due to improper socket insertion during operation.
6. User must wear proper clothing. Loose clothing, long hair, stings, straps, belts and jewelry should not be worn when operating this tool.
7. Before using these tools, make sure that all couplings and plugs are securely mounted. Air hoses which are under pressure will cause a whipping action when disconnecting, this can lead to serious injury!
8. Make certain to stand on a solid or firm location and keep body in well-balanced position while operating this tool.
9. Test run the tool to confirm the rotation direction before practical use. This will reduce the potential hazard due to unexpected rotating direction.
10. In case of tool insert failure, always keep hands away from rotating socket to reduce the risk of being injured, especially when working in confined spaces.
11. Always turn off the air supply and disconnect the air hose before changing socket or making adjustments on the tool.
12. Release the throttle trigger to avoid danger if there is a failure of energy supply and when connecting or disconnecting the air hose.
13. Prolonged use will cause user fatigue. Periodic breaks are recommended for user safety.
14. It is recommended to stop operating the tool whenever the user experiences discomfort, tingling or pain during use.
15. Beware if the compressed air hose breaks unexpectedly, or is being connected or disconnected improperly. This whipping action may cause injury.
16. Always use caution when operating this tool to prevent injury.
17. Avoid storing this tool where it is subject to high humidity.



## Maintenance:

1. Before connecting the air hose to this tool or after operating, apply 4 or 5 drops of pneumatic oil into the air inlet and run it for several seconds, referring this operation to the attached illustration No.1.
2. Maintain this tool regularly by performing the same oiling application every 3 to 4 hours of operation.
3. Do not lubricate tools with flammable or volatile liquids. Use only the lubricant recommended by Mighty-Seven or authorized dealers. Any other lubricant will lead to reduce performance of the tool and permanent damage. Whenever any unauthorized lubricant is used by accident, flush it immediately with recommended pneumatic oil.
4. The impact mechanism also needs to be greased once every 50 hours after practical operation, referring this performance to the attached illustration No.2.
5. Follow all the recycling laws of waste disposal once this tool is no longer usable.

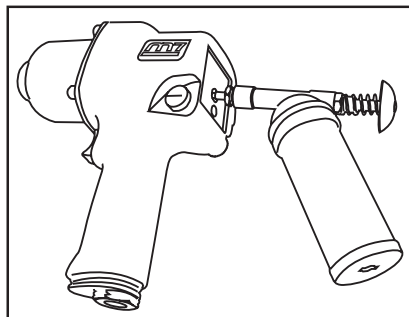
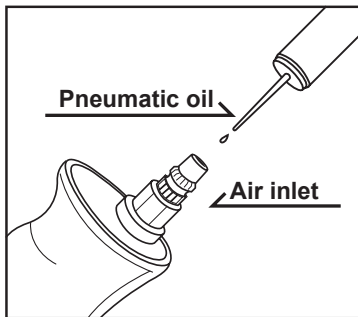

**Regular maintenance    Impact mechanism greasing**



## **Lire ce guide avant toute installation, opération, maintenance ou réparation.**

### **Environnement de travail:**

1. L'outil ne doit pas être utilisé dans un lieu ayant une atmosphère potentiellement explosive.
2. Il est fortement conseillé d'utiliser ce genre d'outils avec une prise au sol ferme et solide.
3. Toujours utiliser l'outillage pneumatique dans un endroit bien ventilé.
4. Des installations encombrées et mal organisées sont une des principales causes de blessures en milieu de travail. Une aire de travail propre et libre de tout obstacle est requise pour assurer la sécurité au travail.

### **Pression et alimentation en air :**

1. La pression d'air maximale recommandée ne devrait jamais excéder les 90 psi (6,3bar). Une utilisation à une pression d'air supérieur peut causer des dommages à l'outil et/ou pour son utilisateur.
2. L'air à la sorti du compresseur devrait être refroidi et passer à travers un filtre capteur d'humidité pour éviter les risques de condensation à l'intérieur de l'outil. L'humidité et la condensation peuvent créer de la rouille et une usure prématurée de l'outil. Pour cette raison, il est recommandé d'installer un filtre à air/lubrificateur quelque part entre l'outil pneumatique et le compresseur.
3. Utilisez un compresseur avec une capacité adaptée pour chaque outil.
4. Nettoyez le tuyau d'alimentation avec une décharge d'air avant chaque utilisation. Ceci évitera que de l'humidité et/ou des impuretés ne pénètrent à l'intérieur de l'outil et ne crée des problèmes de fonctionnement ou une usure prématurée.



1. Tout l'outillage pneumatique devrait être opéré de façon manuelle. Ils sont alimentés par de l'air comprimé et ne sont pas conçus pour être utilisés dans des milieux sous tension électrique.
2. Cet outil est conçu spécifiquement pour le serrage et le desserrage des boulons. Toute autre utilisation de cet outil est fortement déconseillée.
3. Toujours utiliser des douilles ou des accessoires de type Impact sur cet outil. Ne jamais utiliser de douilles ou des accessoires à mains.
4. Le niveau sonore élevé de l'outillage pneumatique peut causer des dommages auditifs permanents. Toujours porter une protection auditive lors de l'utilisation.
5. Il est fortement conseillé de se munir de protection pour les yeux et le visage afin d'éviter les blessures causées par débris ou une douille mal fixée éjectée lors de l'utilisation.
6. L'utilisateur se doit de porter des vêtements adéquats. Des vêtements amples, des cheveux longs, des attaches, sangles, ceintures ou bijoux ne devraient pas être portés lors de l'utilisation de ces outils.
7. Avant d'utiliser ces outils, il faut s'assurer que tous les joints et raccords soient correctement enclenchés. Les tuyaux d'alimentation sous pression peuvent causer de sérieuses blessures s'ils se déconnectent!
8. Il est fortement conseillé d'utiliser ce genre d'outils avec une prise au sol ferme et solide.
9. Vérifiez le sens de rotation de l'outil par un test rapide avant chaque utilisation. Ceci pourrait éviter des blessures dues à un sens de rotation inattendu.
10. En cas d'un bris de la boulonnerie ou d'une douille, toujours tenir les mains éloignées de la partie rotative de l'outil afin d'éviter les risques de blessures, particulièrement dans les endroits confinés.
11. Toujours éteindre l'alimentation en air et débrancher les raccords lors d'un changement de douille ou d'accessoire.
12. Relâchez la gâchette lorsqu'il y a un problème d'alimentation ou lors du débranchement de l'outil.
13. Des périodes d'utilisation prolongée peuvent causer de la fatigue. Des pauses régulières sont conseillées pour augmenter la sécurité de l'utilisateur.
14. Il est recommandé d'arrêter immédiatement le travail lorsqu'un malaise ou une forte fatigue est ressenti lors de l'utilisation prolongée de cet outil.
15. Toujours faire attention à un éventuel bris du tuyau d'alimentation en air et lors de son débranchement intentionnel ou accidentel. Le fouettement du tuyau d'alimentation peut causer des blessures.
16. Toujours être prudent lors de l'utilisation de cet outil pour prévenir les blessures.
17. Évitez de ranger cet outil dans un endroit où l'air est humide.



## Maintenance:

1. Avant l'utilisation ou avant de brancher le tuyau d'alimentation, déposer 4 ou 5 gouttes d'huile pneumatique par l'admission d'air et faire fonctionner l'outil pendant quelques secondes. Pour la manipulation, se référer à l'illustration No.1.
2. Procédez à une lubrification régulière de l'outil à toutes les 3 ou 4 heures d'utilisation.
3. Ne pas lubrifier l'outil avec des produits volatile ou inflammable. Seule l'utilisation de lubrifiants recommandés par M7 ou un revendeur autorisé est permise. Tout autre lubrifiant peut réduire la durée de vie de l'outil. Purger avec de l'huile pneumatique tout outil ayant reçu accidentellement tout autre type de lubrifiant.
4. Le mécanisme de la clé à choc doit également être graissé à toutes les 50 heures d'utilisation consécutive. Pour la manipulation, se référer à l'illustration No.2.
5. Si l'outil est trop endommagé pour être encore utilisé, déposez-le dans une déchetterie pour qu'il soit recyclé.

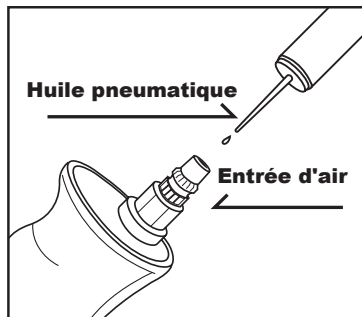

**Entretien régulier**

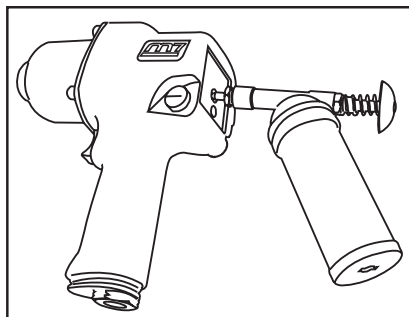

**Lubrification des mécanismes**



## **Bitte lesen Sie die beigelegte Anweisung sorgfältig vor der Installation, der Arbeit, Wartung und dem Wechsel des Zubehörs mit der Fettpresse.**

### **Sicherheitshinweise:**

1. Es ist strikt verboten, die Druckluftschlagschrauber in einem explosionsgefährdeten Arbeitsumfeld zu benutzen.
2. Es ist ratsam, das Werkzeug auf einer festen Arbeitsfläche zu verwenden, z. B. auf einem festen und ebenen Arbeitsplatz.
3. Beachten Sie, dass die Arbeitsumgebung mit dem Druckluftwerkzeug immer gut belüftet sein soll.
4. Vor der Benutzung eines Druckluftwerkzeugs sichern Sie eine saubere, geräumige und feste Arbeitsumgebung ab, da Rutschen, Anstoßen und Zubruchgehen die Hauptgründe für Schadensentstehung sind.

### **Luftversorgungssystem:**

1. Der in der Bedienungsanleitung angegebene maximale Arbeitsluftdruck, 90 psi bzw. 6,3 bar, für das Druckluftwerkzeug ist NICHT zu überschreiten, da dies zu Verletzungen und erhöhtem Materialverschleiß führen kann.
2. Die Druckluftzufuhr soll durch den in der Anlage eingebauten Lufttrockner abgekühlt werden und am Druckluftabgang durch den installierten Filter gefiltert werden. Trotzdem könnte, je nach den Umgebungsverhältnissen, immer wieder Kondenswasser in der Leitung entstehen. Die Feuchtigkeit verursacht bekanntlich Schäden und Leistungsverlust für das Werkzeug. Daher empfehlen wir unseren Kunden, eine Wartungseinheit wie den „Filter, Regler & Öler“ an einer Stelle zwischen der Luftzufuhr und dem Werkzeug zu installieren. Diese zusätzliche Wartungseinheit gewährleistet ein ideales Luftversorgungssystem für die Arbeit mit dem Werkzeug und verhindert gleichzeitig die Korrosionsbildung.
3. Bitte verwenden Sie immer einen Kompressor, der die passende Luftkapazität für das Gerät hat.
4. Vor dem Anschluss eines Druckluftwerkzeugs reinigen Sie mit Gebläseluft den Luftschlauch. Dies verhindert, dass die in dem Luftschlauch existierende Feuchtigkeit und Staub ins Werkzeug eindringen und schützt so vor Korrosionsbildung und Verschleiß des Werkzeugs.





## **! Allgemeine Sicherheitshinweise: !**

1. Dieses Werkzeug kann nur für manuelle Arbeit eingesetzt werden und wird angetrieben mittels der durch einen Kompressor bereitgestellten Druckluft. Dieses Werkzeug ist nicht isoliert gegen Elektroschock.
2. Dieses Werkzeug ist speziell ausgelegt für die Anwendung zum Lösen und Anziehen von Schrauben und Nüssen. Jede andere Verwendung ist strikt verboten.
3. Achtung: Nur schlagfeste Schraubeneinsätze und Stecknüsse verwenden!
4. Bei hohen Geräuschpegeln ab 85 dB(A) ist am Arbeitsplatz ein Gehörschutz zu tragen.
5. Ein bruchsicherer Augenschutz ist stets zu tragen, um sich vor absplitternden Teilen zu schützen.
6. Immer Arbeitsschutzkleidung tragen! Bei der Arbeit sollen eng anliegende Kleidungsstücke getragen werden. Es sollen kein Gürtel, kein Schmuck und keine langen Haare getragen werden.
7. Vor dem Anschluss eines Druckluftwerkzeugs ist unbedingt die Festigkeit der Anschlüsse der Luftleitung zu überprüfen. Umher schlagende Schläuche, die unter Druck stehen, können schwere Verletzungen nach sich ziehen.
8. Das Druckluftwerkzeug NUR auf einem festen, sicheren und einwandfreien Arbeitsplatz einsetzen.
9. Vor der richtigen Verwendung ist ein kurzer Testanlauf des Druckluftwerkzeugs vorzunehmen. Dies verhindert eine zufällige Gefährdung bei der Arbeit wegen unerwartetem Laufrichtungswechsel.
10. Beim Ausfall des Geräts sollen die Hände von dem rotierenden Schraubeneinsatz ferngehalten werden, um Verletzungen zu vermeiden, vor allem, wenn der Arbeitsplatz an einer engen Stelle liegt.
11. Vor einem Zubehörwechsel oder nach Gebrauch ist das Werkzeug grundsätzlich von der Luftleitung abzukuppeln und diese von Druck zu entlasten.
12. Den Druckauslöser des Werkzeugs im Fall eines Motorschadens oder einer Unterbrechung der Luftschlauchverbindung sofort loslassen.
13. Nach lang andauernder Benutzung können extreme Schwingungen Taubheitsgefühle in den Händen hervorrufen. Zu Ihrem eigenen Gesundheitsschutz ist es ratsam, öfters eine Pause bei der Arbeit einzulegen.
14. Die Arbeit mit dem Werkzeug ist sofort einzustellen, wenn sich der Benutzer während der Arbeit unwohl fühlt oder ein Kribbeln empfindet.
15. Achten Sie besonders darauf, dass die Luftzufuhr beim Luftschlauch nicht unerwartet unterbrochen wird bzw. die Luftversorgung ruckartig austritt. Dies kann zu Schäden führen.
16. Das Werkzeug immer ordnungsgemäß und behutsam bei der Arbeit verwenden. Dies ist die beste Präventionsmaßnahme gegen Verletzungen.
17. Lagern Sie das Werkzeug niemals in einer feuchten Umgebung!

## Wartungshinweise

1. Nach dem Gebrauch oder vor dem Anschluss ist es ratsam, mit etwas Öl den Drucklufteingang zu schmieren und nach ein paar Sekunden einen Testlauf zu starten.
2. Das Werkzeug soll regelmäßig - jeweils nach einer 3- oder 4-stündigen Benutzung - mit Schmieröl gewartet werden.
3. Bitte verwenden Sie auf keinen Fall entflammables oder flüchtiges Öl zur Wartung des Werkzeugs. NUR das von dem Hersteller angegebene Schmieröl verwenden!
4. Nach der endgültigen Abnutzung des Werkzeugs befolgen Sie alle Umweltschutzrichtlinien für die Abfallentsorgung bzw. Abfallbeseitigung.

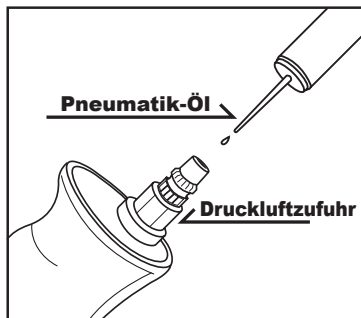

**Reguläre Wartung**

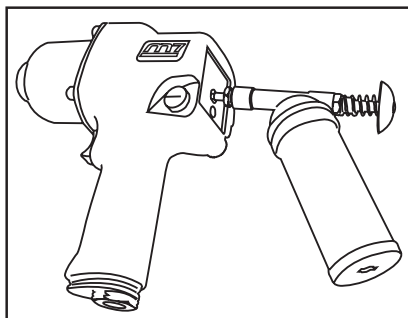

**Impact mechanism lubricating**



**Lea este manual cuidadosamente antes de instalar, operar, realizar el servicio técnico o la reparación de la herramienta.**

### **Ambiente de trabajo:**

1. El uso de estas herramientas en cualquier ambiente potencialmente explosivo está totalmente prohibido.
2. Es siempre recomendado que este tipo de herramientas sean operadas parándose sobre un lugar sólido o firme.
3. Siempre usar estas herramientas en un lugar con buena ventilación.
4. Resbalarse, tropezarse y caerse son las mayores causas de daños potencialmente serios, por lo que se recomienda operar las herramientas en una superficie limpia y libre de abarrotamiento dentro del área de trabajo.

### **Requerimientos de surtido de aire y conexiones:**

1. La presión máxima de operación no debe exceder de 90 psi (6.3bar). Una presión de aire mayor podría crear condiciones de operación no seguras para la herramienta y el usuario.
2. El aire comprimido debe ser enfriado y tener un filtro de agua instalado en el lado de salida del compresor. Aún con el filtro de agua instalado, algo de agua podría condensarse todavía en las tuberías o la manguera y entrar en el mecanismo de la herramienta, causando daños prematuros a la misma. Por ello es recomendable instalar un dispositivo filtro-lubricador de aire en algún punto de la línea entre la herramienta y el compresor.
3. Siempre usar el compresor de aire de la capacidad apropiada para operar cada herramienta.
4. Limpiar la manguera con un soplo de aire comprimido antes de conectar la manguera a la herramienta de aire. Esto evitará que la humedad y la suciedad dentro de la manguera ingresen a la herramienta causando su oxidación o malfuncionamiento.



## **Advertencia:**

1. Esta herramienta debe ser usada únicamente como una herramienta operada manualmente. Funciona con compresora de aire y no está aislada contra choques eléctricos.
2. Esta herramienta está especialmente diseñada para ajustar o soltar tuercas o tornillos. Cualquier otro uso de esta herramienta ajeno al propósito para el que fue diseñada está estrictamente prohibido.
3. Utilice únicamente dados y accesorios neumáticos para esta herramienta. Nunca use dados o accesorios de tipo manual.
4. Sonidos de niveles altos podrían causar daños al oído. Use siempre protección de oídos al operar esta herramienta.
5. El uso de protección de ojos y cara puede reducir el peligro en caso de que el dado sea expulsado a alta velocidad desde la herramienta a causa de una mala inserción del dado durante el uso.
6. El operario debe usar ropa apropiada. Ropa muy suelta, pelo largo, cordones, tirantes, correas y joyería no deben ser usados cuando se opere esta herramienta.
7. Antes de usar estas herramientas, asegúrese que todas las piezas de acople y enchufes estén conectados de forma segura.
8. Asegúrese de pararse sobre una base sólida o firme y mantenga el cuerpo en una posición con buen balance al operar esta herramienta.
9. Realice una prueba de encendido de la herramienta para confirmar la dirección de rotación antes de ponerla en uso. Esto reducirá daños potenciales causados por una dirección de rotación inesperada.
10. Siempre mantenga las manos apartadas del dado de rotación para reducir el riesgo de lesionarse en caso de una falla en la inserción de la herramienta, especialmente cuando se trabaja en espacios confinados.
11. Siempre apague el suministro de aire y desconecte la manguera de aire antes de cambiar el dado o de hacer ajustes a esta herramienta.
12. Suelte el gatillo de aceleración para evitar peligros si existe una falla en el suministro de energía eléctrica o cuando conecte o desconecte la manguera de aire.
13. Largos períodos de uso prolongado causan fatiga del usuario. Descansos periódicos son recomendados para seguridad del usuario.
14. Se recomienda interrumpir el uso de la herramienta en caso de experimentar incomodidad, cosquilleo o dolor durante su uso.
15. Tenga cuidado si la manguera de aire se rompe inesperadamente, o si se conecta o desconecta de manera inapropiada. El efecto azote de tal acción podría causar lesiones.
16. Siempre opere esta herramienta con cuidado para prevenir lesiones.
17. Evite almacenar esta herramienta en lugares muy húmedos.



## Mantenimiento:

1. Antes de conectar la manguera de aire o luego de usarla, aplique 4 ó 5 gotas de aceite neumático en la entrada de aire y déjela encendida por varios segundos. Ver la ilustración No. 1.
2. Realice un mantenimiento regular de esta herramienta repitiendo la misma operación lubricación cada 3 ó 4 horas de uso.
3. No utilice líquidos inflamables o volátiles para lubricar esta herramienta. Utilice únicamente el lubricante recomendado por Mighty-Seven o agentes autorizados. Cualquier otro lubricante producirá una disminución en el desempeño de la herramienta y daño permanente. Si se utiliza accidentalmente un lubricante no autorizado, quítelo inmediatamente vertiendo encima aceite neumático recomendado.
4. Engrasar también el mecanismo de impacto luego de cada 50 horas de uso, como se muestra en la ilustración 2, para mantener su buen funcionamiento.
5. Respete todas las leyes de reciclaje y desechos una vez que esta herramienta sea descartada.

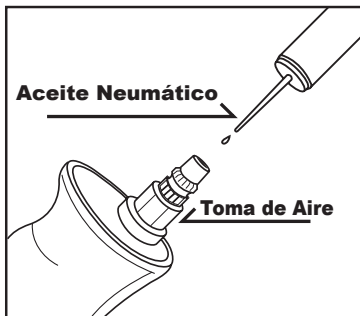

**Mantenimiento regular**

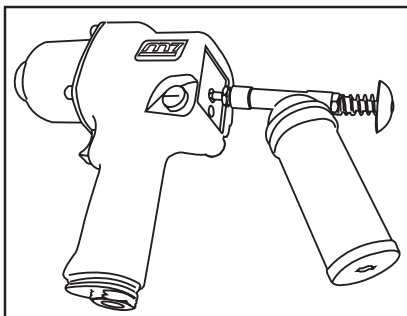

**Lubricación del sistema de impacto**



## **Leia atentamente este manual antes de instalar, operar, carregar ou reparar sua engraxadeira pneumática.**

### **Recomendações sobre a área de trabalho:**

1. Nunca trabalhe com esta ferramenta pneumática em ambientes potencialmente explosivos.
2. Deve oferecer uma base firme e sólida o piso sobre o qual o operador trabalhará com esta ferramenta pneumática.
3. Trabalhe com esta ferramenta somente em áreas bem ventiladas.
4. Tropeços, escorregões e quedas, enquanto estiver trabalhando com ferramentas pneumáticas, podem ser potencialmente perigosos. Procure manter a área de trabalho seca e livre de obstáculos.

### **Requisitos para a linha de ar e conexões:**

1. A pressão máxima de trabalho não deve ultrapassar 90 psi (6,3 bar). Pressões mais altas podem danificar a ferramenta e machucar o operador.
2. O ar comprimido deve ser resfriado e filtrado na saída do compressor. Mesmo tomando estas medidas, um pouco de umidade pode se condensar dentro das tubulações e entrar na ferramenta pneumática, reduzindo sua vida útil. Por essa razão é recomendada a instalação de um conjunto de filtro e lubrificador de ar em algum ponto da linha entre a ferramenta e o compressor.
3. O compressor deve ter capacidade compatível com o consumo do número de ferramentas pneumáticas a ele conectadas.
4. Limpe o interior da mangueira com um jato de ar comprimido antes de conectá-la à ferramenta pneumática. Esse procedimento evita que sujeira e umidade sejam carregadas para dentro da ferramenta, danificando-a.



## **! Atenção: !**

1. Esta é uma ferramenta de uso manual apenas. Ela é alimentada por ar comprimido e não possui isolamento elétrico algum.
2. Esta ferramenta foi projetada especificamente para apertar ou soltar parafusos e porcas. É vedado seu uso para qualquer outra finalidade.
3. Use somente soquetes e acessórios de impacto com esta ferramenta pneumática. Soquetes e acessórios comuns para uso manual não devem ser utilizados, pois os estilhaços poderão ferir o operador e pessoas ao seu redor.
4. A exposição a ruídos elevados pode provocar danos auditivos irreversíveis. Use sempre protetores auriculares ao trabalhar com esta ferramenta pneumática.
5. O uso de óculos e máscara de proteção reduz o risco de ferimentos decorrentes de soquetes ou acessórios que venham a se soltar acidentalmente durante o trabalho.
6. O uniforme deve ser adequado ao trabalho com ferramentas de alta rotação. Tiras e pontas soltas de tecido, cintas, correntes de pescoço ou pulseiras, assim como cabelos compridos, podem se enroscar na ferramenta e provocar sérios acidentes.
7. Antes de usar esta ferramenta pneumática verifique se os soquetes e acessórios estão firmemente encaixados. Observe também se os engates da mangueira de ar estão corretamente conectados.
8. Trabalhe somente sobre um piso ou base suficientemente firme e mantenha uma posição corporal que lhe garanta o total equilíbrio e controle durante o trabalho com esta ferramenta.
9. Confirme o sentido de rotação do eixo da ferramenta antes de iniciar um trabalho. Isso evita os acidentes decorrentes de funcionamento em sentido inesperado.
10. Mantenha as mãos longe dos soquetes enquanto a ferramenta estiver sendo utilizada, especialmente ao trabalhar em locais de difícil acesso.
11. Sempre desconecte a mangueira de ar antes de efetuar alguma troca de soquetes ou alterar o sentido de rotação da ferramenta.
12. Solte imediatamente o gatilho da ferramenta, se houver queda de energia ou se a mangueira de ar se desconectar.
13. O trabalho ininterrupto por longos períodos pode causar fadiga. Recomenda-se efetuar pausas de vez em quando para evitar acidentes decorrentes do cansaço do operador.
14. Interrompa o trabalho imediatamente se sentir desconforto, dor ou mesmo formigamento dos membros ao usar esta ferramenta pneumática.
15. Esteja sempre atento a um possível chicoteamento da mangueira de ar, caso ela se rompa ou se desconecte acidentalmente da ferramenta.
16. Evite acidentes concentrando-se integralmente no trabalho enquanto a ferramenta pneumática estiver em uso.
17. Evite guardar a ferramenta pneumática em locais sujeitos a muita umidade.

## Manutenção:

1. Antes de conectar a mangueira de ar à ferramenta, pingue 4 a 5 gotas de óleo no furo de entrada de ar. Conecte a mangueira, aperte o gatilho e deixe a ferramenta funcionando por alguns segundos para lubrificá-la internamente. Observe a figura número 1.
2. Lubrifique novamente a ferramenta a cada intervalo de 3 ou 4 horas trabalhadas.
3. Utilize apenas óleo máquina SAE 10-20 para lubrificar sua ferramenta pneumática. Se outro líquido foi introduzido acidentalmente na máquina, faça com que ele seja expelido, introduzindo um volume maior de óleo SAE 10-20.
4. O mecanismo de impacto também deve ser engraxado a cada 50 horas conforme ilustramos na figura 2.
5. Ao descartar essa ferramenta pneumática ou suas partes, verifique a possibilidade de encaminhá-la para centros de reciclagem, colaborando para a reduzir a quantidade de lixo no meio-ambiente.



**Lubrificação periódica**

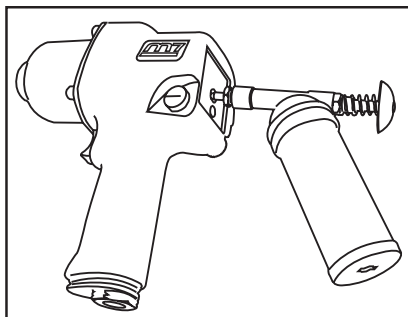

**Impact mechanism  
lubricating**





## **Перед эксплуатацией внимательно прочтите инструкцию**

### **Рабочая обстановка:**

1. Использование инструментов в любой потенциально взрывоопасной среде строго запрещено.
2. Рекомендуется использовать инструменты стоя на твердой и ровной поверхности.
3. Всегда используйте инструменты в хорошо проветриваемом помещении.
4. Основными причинами потенциальных серьезных травм являются падения, спотыкания подскользывания, поэтому, Перед началом работы с инструментами настоятельно рекомендуется приготовить чистую и свободную поверхность и порядок в рабочей зоне .

### **Подача воздуха и требования к соединению:**

1. Максимальное рекомендуемое давление воздуха при эксплуатации не должно превышать 90 psi (6.3 атм.). Привышение атмосферного давления может создать небезопасные условия для работы с инструментом.
2. Сжатый воздух должен быть охлажден и на выходе из компрессора должен быть установлен фильтр влагоотделитель. Даже с фильтром, конденсат может скапливаться в трубопроводе или шланге, что может быть причиной преждевременного износа инструмента. Поэтому рекомендуется установить воздушный фильтр-лубликатор между инструментом и компрессором.
3. Всегда используйте воздушный компрессор надлежащей частоты для каждого инструмента.
4. Продуйте шланг перед соединением с пневматическим инструментом. Это позволит избежать попадания влаги и пыли внутрь инструмента и причинения жавчины или неисправности.



## **! Предостережения перед использованием: !**

1. Этот инструмент может использоваться только в качестве ручного инструмента. Он рассчитан только на питание сжатым воздухом.
2. Инструмент разработан специально для затяжки или ослабления болтов или гаек. Любое применение или использование этого инструмента не по назначению строго запрещено.
3. Используйте только приспособления и ударные торцевые головки для пневматического оборудования.
4. Высокий уровень шума может привести к повреждению слуха. Всегда применяйте защиту органов слуха при работе с инструментом.
5. Применение защиты глаз / лица могут снизить опасность поражения вылетевшей насадкой, в связи с ненадлежащим присоединением насадки в процессе эксплуатации.
6. Пользователь должен носить надлежащую одежду. Свободная одежда, длинные волосы, ремни, и ювелирные изделия не следует носить при работе этим инструментом.
7. Перед тем как использовать инструмент, убедитесь, что все муфты и вилки надежно закреплены. Воздушные шланги, которые находятся под давлением при спонтанном отключении могут привести к серьезным травмам!
8. Убедитесь, что стоите на твердой, устойчивой поверхности, тело находится в хорошо сбалансированной позиции при работе этим инструментом.
9. Произведите пробный пуск инструмента, чтобы подтвердить направление вращения до практического использования. Это позволит уменьшить потенциальную опасность в связи с неожиданным направлением вращения.
10. Держите руки дальше от вращающейся части, во избежание травм в случае неудачного соединения.
11. Всегда отключайте подачу воздуха и отсоединяйте воздушный шланг перед заменой насадки или внесением изменений в инструменте.
12. Необходимо отпустить дроссельный триггер, чтобы избежать опасности, при сбое энергоснабжения и при подключении или отключении воздушного шланга.
13. Периодические перерывы рекомендуются для безопасности пользователя. Длительные периоды использования могут вызвать усталость пользователя.
14. Рекомендуется остановить эксплуатацию инструмента, если пользователь почувствовал дискомфорт, покалывание или боль во время работы.
15. Опасайтесь спонтанного обрыва шланга подачи сжатого воздуха, если он был подключен или отключен неправильно. Это может привести к травмам.
16. Всегда будьте осторожны при работе этим инструментом, для избежания травм.
17. Избегайте хранения инструмента в местах с повышенной влажностью.



## обслуживание:

1. Перед подключением воздушного шланга, или после применения продуйте шланг с 4-5 капель пневматического масла по прилагаемому рисунку № 1.
2. При постоянной работе инструмента рекомендуется смазывать инструмент каждые 3, 4 часа.
3. Для смазки оборудования не используйте легко воспламеняющиеся вещества. Используйте только смазки рекомендованные Mighty-Seven или уполномоченных дилеров. Использование не рекомендованных смазок может привести к снижению производительности, или к повреждению. При случайном использовании не рекомендуемой смазки, замените смазку на специальную.
4. Ударный механизм также должен быть смазан каждые 50 часов эксплуатации, в соответствии с иллюстрацией № 2.
5. Соблюдайте все законы переработки отходов после завершения эксплуатации оборудования.



**регулярное техобслуживание**

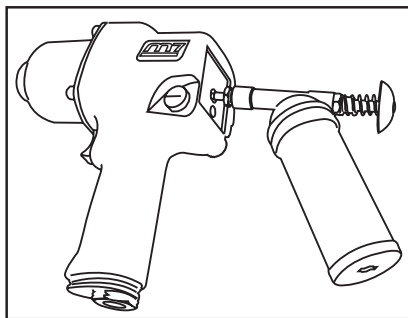

**смазка ударного механизма**



## **Před instalací, provozem, údržbou či opravou si přečtěte pozorně tento návod.**

### **Doporučení pro práci s nářadím**

1. Používání tohoto nářadí v prostředí s možností výbuchu je striktně zakázáno.
2. Při práci s tímto nářadím pracujte vždy vestoje a stůjte na pevné ploše.
3. Vždy používejte toto nářadí v dobře větraném prostoru.
4. Uklouznutí, zakopnutí a pád jsou nejčastější příčinou úrazu. V pracovním prostoru proto vždy udržujte pořádek a před zahájením práce jej vždy ukliděte.

### **Požadavky na stlačený vzduch a připojení ke zdroji vzduchu**

1. Maximální doporučený tlak vzduchu během provozu nesmí překročit 6.3 bar (90 psi). Vyšší tlak vzduchu může způsobit nebezpečné provozní podmínky pro nářadí a uživatele.
2. Stlačený vzduch by měl být zbaven vlhkosti pomocí sušičky a nečistot pomocí filtru instalovaného za výstup z kompresoru. Když je instalován pouze filtr, část vlhkosti stále kondenzuje v potrubním rozvodu nebo v hadici a při vstupu do nářadí způsobuje jeho poškození a snižuje životnost. V takovém případě vždy doporučujeme instalovat filtr co nejbližší nářadí.
3. Vždy používejte pouze kompresor s dostatečným výkonem zajišťující plynulou dodávku stlačeného vzduchu.
4. Přívodní hadici před použitím vyčistěte proudem vzduchu. Tím zabráníte vstupu jak vlhkosti, tak pevných nečistot do nářadí.



## **! Предостережения перед использованием: !**

1. Toto nářadí může být používáno pouze jako vzduchové ruční nářadí. Je napájeno stlačeným vzduchem a není chráněno proti elektrickému napětí.
2. Toto nářadí je speciálně navrženo pro povolování a utahování šroubů a matic. Jakákoliv jiná aplikace je výrobcem striktně zakázána.
3. Jako příslušenství pro toto nářadí používejte pouze oříšky s odolností na kroutící moment. Nikdy nepoužívejte oříšky pro ruční ráčny a utahovány nebo jiná příslušenství.
4. Vysoká hluchnost může způsobit poškození sluchu. Při práci s nářadím si vždy chraňte uši ochrannými prostředky.
5. Při používání ochrany obličeje a očí snižujete nebezpečí úrazu způsobeného vymrštěným oříškem při vkládání nebo vyndávání z nářadí během provozu.
6. Uživatel musí nosit ochranný oděv. Při provozu nářadí je zakázáno nosit volné oblečení, volně rozpuštěné dlouhé vlasy, šle, pásky, popruhy či šperky.
7. Před použitím nářadí se ujistěte, zda jsou pevně namontovány všechny spojky a šroubení. Vzduchové hadice, které jsou pod tlakem mohou při odpojení způsobit závažná zranění!
8. Při provozu nářadí stůjte na pevném podkladu a mějte tělo ve stabilní poloze.
9. Před použitím nářadí proveďte naprázdno testovací kontrolu směru rotace. Redukujete tak výrazně zranění způsobená špatným směrem otáček.
10. V případě závady držte ruce vždy pryč od rotujících oříšků, zejména v uzavřených prostorách.
11. Před výměnou oříšků vždy vypněte přívod vzduchu, odpojte hadici nebo jinak zajistěte nářadí před samovolným spuštěním.
12. Pokud dojde k výpadku dodávky vzduchu nebo v okamžiku připojování a odpojování hadice vždy uvolněte spoušť.
13. Dlouhodobé používání nářadí způsobuje únavu obsluhy. Pro uživatele vždy doporučujeme vykonávání bezpečnostních přestávek.
14. Doporučuje se přerušit provoz v případech kdy uživatel pociťuje nepohodlí, brnění nebo bolest.
15. Dejte si pozor na možné vymrštění hadice se stlačeným vzduchem, které může způsobit vážná poranění.
16. Při provozu nářadí buďte vždy pozorní, předcházejte možným nebezpečím.
17. Neukládejte toto nářadí do míst s vysokou vlhkostí.

## обслуживание:

1. Před zahájením práce kápněte do hadice 4 až 5 kapek oleje pro pneumatické nářadí a spusťte jej naprázdno na několik sekund. Viz ilustrační obr. 1
2. Každé 3-4 hodiny provozu doplňujte olej jako v bodě 1.
3. Nemažte toto nářadí hořlavými nebo těkavými látkami. Používejte výhradně mazivo firmy Mighty-Seven, které je k dostání u autorizovaných prodejců. Jakékoliv jiné mazivo způsobí snížení výkonu nebo trvalé poškození nářadí. V případě, že omylem použijete jiné než doporučené mazivo, ihned promažte nářadí předepsaným olejem.
4. Utahovací mechanismus musí být promazán po každých 50 provozních hodinách tak jak je znázorněno na obr.2
5. Jakmile již není nářadí použitelné, řiďte se zákony týkajícími se likvidace odpadu.

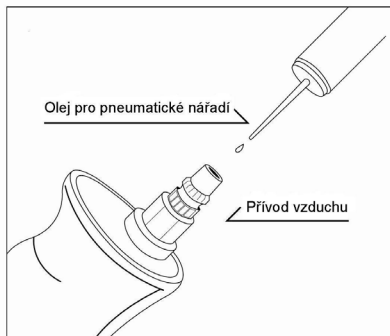

**Pravidelná údržba**

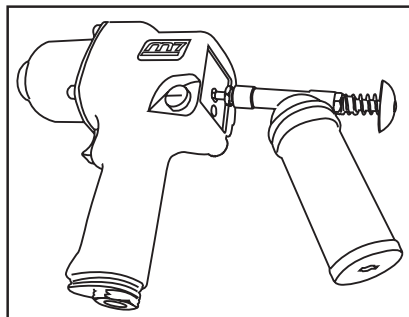

**Mazání utahovacího mechanismu**



**Pred inštaláciou, prevádzkou, údržbou či opravou si prečítajte pozorne tento návod.**

### Doporučenie pre prácu s náradím

1. Používanie tohto náradia v prostredí s možnosťou výbuchu je striktné zakázané.
2. Pri práci s týmto náradím pracujte vždy v stoji a stojte na pevnej ploche.
3. Vždy používajte toto náradie v dobre vetranom priestore.
4. Pošmyknutie, zakopnutie a pád sú najčastejšie príčinou úrazu. V pracovnom priestore preto vždy udržujte poriadok a pred zahájením práce ho vždy poupratujte.

### Požiadavky na stlačený vzduch a pripojení ke zdroji vzduchu

1. Maximálny doporučený tlak vzduchu počas prevádzky nesmie prekročiť 6.3 bar (90 psi). Vyšší tlak vzduchu môže spôsobiť nebezpečné prevádzkové podmienky pre náradie a užívateľa.
2. Stlačený vzduch by mal byť zbavený vlhkosti pomocou sušičky a nečistoty pomocou filtra inštalovaného za výstup z kompresora. Keď je inštalovaný len filter, časť vlhkosti stále kondenzuje v potrubnom rozvode alebo v hadici a pri vstupe do náradia spôsobuje jeho poškodenie a znižuje životnosť. V takomto prípade vždy doporučujeme inštalovať filter čo najbližšie k náradiu.
3. Vždy používajte len kompresor s dostatočným výkonom zaisťujúcim plynulú dodávku stlačeného vzduchu.
4. Prívodnú hadicu pred použitím vyčistite prúdom vzduchu. Tým zabránite vstupu ako vlhkosti, tak pevných nečistôt do náradia.

## **Предостережения перед использованием:**

1. Toto náradie môže byť používané len ako vzduchové ručné náradie. Je napájané stlačeným vzduchom a nie je chránené proti elektrickému napätiu.
2. Toto náradie je špeciálne navrhnuté pre povoľovanie a uťahovanie skrutiek a matíc. Akákoľvek iná aplikácia je výrobcom striktné zakázaná.
3. Ako príslušenstvo pre toto náradie používajte len orechy s odolnosťou na krútiaci moment. Nikdy nepoužívajte orechy pre ručné račne a uťahovákaly alebo iné príslušenstvo.
4. Vysoká hlučnosť môže spôsobiť poškodenie sluchu. Pri práci s náradím si vždy chráňte uši ochrannými prostriedkami.
5. Pri používaní ochrany tváre a očí znižujete nebezpečenstvo úrazu spôsobené vymršteným orechom pri vkladaní alebo vyberaní z náradia počas prevádzky.
6. Užívateľ musí nosiť ochranný odev. Pri prevádzke náradia je zakázané nosiť voľné oblečenie, voľne rozpustené dlhé vlasy, traky, opasky, popruhy či šperky.
7. Pred použitím náradia sa uistite, či sú pevne namontované všetky spojky a šroubenia. Vzduchové hadice, ktoré sú pod tlakom môžu pri odpojení spôsobiť závažné zranenia!
8. Pri prevádzke náradia stojte na pevnom podklade a majte telo v stabilnej polohe.
9. Pred použitím náradia prevedte naprázdno testovaciu kontrolu smeru otáčania. Redukujete tak výrazne zranenia spôsobené zlým smerom otáčok.
10. V prípade závady držte ruky vždy preč od rotujúcich orechov, hlavne v uzavretých priestoroch.
11. Pred výmenou orechov vždy vypnite prívod vzduchu, odpojte hadicu alebo inak zaistíte náradie pred samovoľným spustením.
12. Pokiaľ dôjde k výpadku dodávky vzduchu alebo v okamihu pripojovania a odpojovania hadice vždy uvoľnite spúšť.
13. Dlhodobé používanie náradia spôsobuje únavu obsluhy. Pre užívateľa vždy doporučujeme vykonávanie bezpečnostných prestávok.
14. Doporučuje sa prerušiť prevádzku v prípadoch keď užívateľ pociťuje nepohodlie, brenenie alebo bolesť.
15. Dejte si pozor na možné vymrštenie hadice so stlačeným vzduchom, ktoré môže spôsobiť vážne poranenia.
16. Pri prevádzke náradia buďte vždy pozorný, predchádzajte možným nebezpečenstvám.
17. Neukladajte toto náradie do miest s vysokou vlhkosťou.





## Údržba

1. Pred zahájením práce kvapnite do hadice 4 až 5 kvapiek oleja pre pneumatické náradie a spustíte ho naprázdno na niekoľko sekúnd. Viď ilustračný obr. 1
2. Každé 3-4 hodiny prevádzky doplňte olej ako v bode 1.
3. Nemažte toto náradí horľavými alebo odparujúcimi sa látkami. Používajte výhradne mazivo firmy Mighty-Seven, ktoré je k dostaniu u autorizovaných predajcov. Akékoľvek iné mazivo spôsobuje zníženie výkonu alebo trvalé poškodenie náradia. V prípade, že omylom použijete iné než doporučené mazivo, ihneď premažte náradie prepísaným olejom.
4. Uťahovací mechanizmus musí byť premazaný po každých 50 prevádzkových hodinách tak ako je znázornené na obr.2
5. Ako náhle už nie je náradie použiteľné, riadte sa zákonom týkajúcim sa likvidácie odpadu.

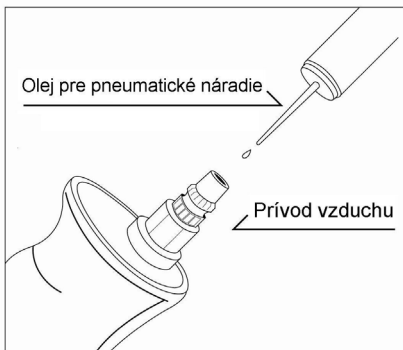

**Pravidelná údržba**

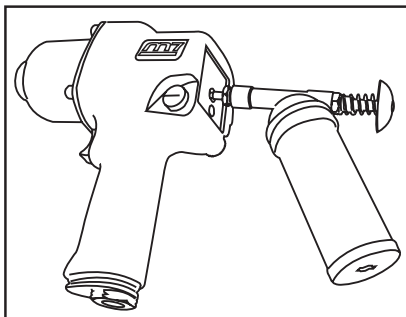

**Mazanie utáhovacieho mechanizmu**



进行安装、操作、维修或更换零件之前，请务必详读本使用手册。

### 工作环境：

1. 严格禁止在任何具有爆炸性气体的环境中使用本气动工具。
  2. 当使用本气动工具时务必站立在坚实稳固的物体或位置上。
  3. 使用本气动工具的场所，其通风条件必须十分良好。
  4. 滑倒、绊倒和从高处跌落…等等状况乃操作气动工具时最容易发生的意外状况，因此在操作之前，务必先将工作场所清理干净。
- .....

### 风源及安装需求：

1. 操作本气动工具的最大空气压力值不得超过90psi。高于此压力值时将可能对本气动工具或使用者带来危险。
2. 用于本气动工具的压缩空气必须经过冷却处理，在空压机出口端务必加装一只过滤器，以便过滤压缩空气中的水分。即便如此，仍会有少部分的水气凝结于空压管路当中，甚至渗进本气动工具的机械结构内部，造成本气动工具难以预期的损害。是故，压缩空气的管路在进入本气动工具之前的某适当位上，应予加装一只三点组合。
3. 使用者应根据各种不同气动工具的需求，选择不同规格的空气压缩机。
4. 开始操作本气动工具之前，应先将管路中的水气排除干净。如此，当可避免残留在压缩空气中的水分或灰尘进入本气动工具内部，将影响到本气动工具的正常性能，甚至造成损坏。



## ! 作业注意事项: !







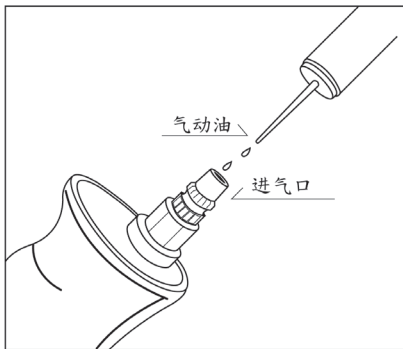





1. 本气动工具完全采用压缩空气来加以驱动，仅限以手动方式进行操作。因本气动工具并不具备绝缘效果，故，使用时应特别注意不可接近电源。
2. 本气动工具乃专为锁紧或松脱螺栓及螺帽而设计，除前述用途之外，其它各类的不当使用均必须严格禁止。
3. 为安全性考虑，本气动工具仅可搭配气动专用套筒或附件来使用，绝对严禁使用手动套筒或配件。
4. 高分贝的噪音可能会使听力受损。故，当使用本气动工具时请务必戴上防护耳罩。
5. 为防范因意外导致套筒高速飞出而造成危险，操作本气动工具时请务必穿戴眼部 / 脸部护具。
6. 使用者在使用本气动工具时，应绝对避免穿着宽松的衣服或配戴过长的腰带、珠宝、首饰…等等物品；长头发亦必须包扎妥当。
7. 操作本气动工具之前，请务必确认所有接头都已妥善接合。当空压软管内仍充满压缩空气时，若贸然脱离接头，将有可能导致空压软管任意甩荡的情况，此现象十分容易造成危险，宜特别小心。
8. 正式使用本气动工具之前应先进行试转以确认铁轴(铁砧)运转的方向。此动作可有效降低因错误反转所带来的潜在性危险。
9. 为防止因装置套筒不确实所可能造成的危险，操作者手指必须时时远离转动中的套筒——特别是在狭窄的空间作业时。
10. 更换套筒或进行任何调整动作之前，请务必关闭空压风源，并将本气动工具与空压软管脱离。
11. 当连接或脱离空压软管时，风源供应若产生问题，应立即释放扳机，以免造成危险。
12. 长时间使用本气动工具将会造成使用者疲劳，为了使用者的安全着想，请务必实施周期性地休息。
13. 使用者在操作中如遇任何不适、颤抖、或疼痛，请务必立即停机休息。
14. 不当拆卸、连接空压软管，或非预期性的软管断裂都将造成空压软管的任意甩动，此类危险状况，操作之时宜特别留心。
15. 使用者在操作当中宜时时谨慎小心，以免免任何潜在性危险。
16. 请勿储放本气动工具于潮湿的环境当中。

## 维护与保养:













1. 本气动工具于使用之前及使用完毕之后, 均应从进气口处加入4或5c. c的气动油, 并空转几秒以清洁各零件。请参照附图一进行此项保养。
2. 每使用3至4个小时, 请务必再次添加气动油, 并空转几秒以进行保养。此项作业对于维护本气动工具的性能, 及提升其使用寿命具有绝对的帮助。
3. 保养本气动工具时绝对禁止使用任何易燃性或具挥发性的液体。仅建议使用经本厂授权的服务中心所介绍的润滑油脂。任何其它的润滑油脂均有可能降低本气动工具的功能, 甚至造成永久性的损坏。当不小心使用到其它润滑油脂时, 则请立即用建议的润滑油脂将其清洗干净。
4. 本气动工具每经操作50小时之后, 锤打结构应以多功能润滑油脂进行保养。
5. 如果本气动工具已然不堪使用, 请务必遵照相关废弃物回收法令进行后续处置。















气动工具之日常润滑保养

Item No.	Square Drive inch	Bolt Capacity inch	Torque Range FT-LB	Max Torque FT-LB	Free Speed R.P.M	Avg. Air Consumption CFM	Air Pressure PSI	Overall Length inch	Net Weight LBS	Air Hose inch	Sound Pressure (Power) EN ISO 15744 dBA	Vibration level m/s <sup>2</sup>
Illustrator												
NC-6218	3/4"	1-1/16"	200-1400	1500	6000	6.43	90	12-9/16"	12.5	1/2"	106	3.3
NC-8212	1"	1-1/16"	200-1000	1300	6000	6.0	90	9-1/4"	9.6	1/2"	91.2	5.0
NC-8216	1"	1-3/8"	200-1600	1800	6000	9.0	90	13-1/2"	15.5	1/2"	102	9.3
NC-8226	1"	1-3/8"	200-1600	1800	6000	9.0	90	19-3/16"	18.4	1/2"	102	9.3
NC-8219	1"	1-7/16"	200-1600	1800	4000	11.0	90	12-13/32"	21.6	1/2"	103.4	16.7













Uncertainty K=0.5a if a ≤ 5 m/s<sup>2</sup> or K=0.4a if a > 5 m/s<sup>2</sup>

Référence	Carré cond inch	Cap. Boulon mm	Couple recommandé Nm	Couple maxi Nm	Vitesse à vide R.P.M	Cons. D'air moyenne l/min	Pression bar	Longueur mm	Poids kg	Tuyau d'air mm	Niveau sonore dBA EN ISO 15744	Niveau de vibration m/s <sup>2</sup>
												
NC-6218	3/4"	27	271-1898	2034	6000	182	6.3	320	5.7	13	106	3.3
NC-8212	1"	27	271-1356	1762	6000	170	6.3	235	4.4	13	91.2	5.0
NC-8216	1"	33	271-2170	2441	6000	254	6.3	343	7.0	13	102	9.3
NC-8226	1"	33	271-2170	2441	6000	254	6.3	487	8.4	13	102	9.3
NC-8219	1"	36	271-2170	2441	4000	311	6.3	315	9.84	13	103.4	16.7













Incertitude K=0.5a si a ≤ 5m/s<sup>2</sup> ou K=0.4a si a > 5m/s<sup>2</sup>

Artikel-Nr.	Vierecke Antrieb inch	Bolzen Größe mm	Empf. Drehmoment Nm	Max. Drehmoment bei Lösen Nm	Leerlauf Drehzahl R.P.M	Luftverbrauch l/min	Arbeitsdruck bar	Gesamtlänge mm	Nettogewicht kg	Empf. Luftschlauch mm	Schalldruckpegel dBA EN ISO 15744	Vibrationsniveau m/s <sup>2</sup>
												
NC-6218	3/4"	27	271-1898	2034	6000	182	6.3	320	5.7	13	106	3.3
NC-8212	1"	27	271-1356	1762	6000	170	6.3	235	4.4	13	91.2	5.0
NC-8216	1"	33	271-2170	2441	6000	254	6.3	343	7.0	13	102	9.3
NC-8226	1"	33	271-2170	2441	6000	254	6.3	487	8.4	13	102	9.3
NC-8219	1"	36	271-2170	2441	4000	311	6.3	315	9.84	13	103.4	16.7













Unsicherheit K = 0.5 wenn ein ≤ 5 m/s<sup>2</sup> oder K = 0.4a, wenn a > 5 m/s<sup>2</sup>

Modelo	Matiz Cuadrada	Capacidad de Fermo	Rango de Torque	Torque Máximo	Velocidad Libre	Consumo de Aire Promedio	Presión de Aire	Longitud Total	Peso Neto	Manguera de Aire	Presión Sonora EN ISO 15744	Nivel de vibración
	inch	mm	Nm	Nm	R.P.M	L/min	bar	mm	kg	mm	dBA	m/s <sup>2</sup>
												
NC-6218	3/4"	27	271-1898	2034	6000	182	6.3	320	5.7	13	106	3.3
NC-8212	1"	27	200-1000	1300	6000	170	6.3	235	4.4	13	91.2	5.0
NC-8216	1"	33	271-2170	2441	6000	254	6.3	343	7.0	13	102	9.3
NC-8226	1"	33	271-2170	2441	6000	254	6.3	487	8.4	13	102	9.3
NC-8219	1"	36	200-1600	1800	4000	311	6.3	315	9.8	13	103.4	16.7













variable K=0.5a si a ≤ 5 m/s<sup>2</sup> ó K=0.4a si a > 5 m/s<sup>2</sup>

Código	Encaixe Quadrado	Capacidade do parafuso	Faixa de Torque	Torque Máximo	Velocidade Livre	Consumo de Ar	Pressão de operação	Comprimento Total	Peso	Diâmetro interno da mangueira	Nível de ruído EN ISO 15744	Nível de vibração
	polegada	polegada	kgfm	kgfm	R.P.M	L/min	PSI	mm	kg	polegada	dBA	m/s <sup>2</sup>
												
NC-6218	3/4"	1-1/16"	27.6 a 193.2	207	6000	182	90	320	5.7	1/2"	106	3.3
NC-8212	1"	1-1/16"	27.6 a 138.3	179.7	6000	170	90	235	4.4	1/2"	91.2	5.0
NC-8216	1"	1-3/8"	27.6 a 221.3	2441	6000	254	90	343	7.0	1/2"	102	9.3
NC-8226	1"	1-3/8"	27.6 a 221.3	249	6000	254	90	487	8.4	1/2"	102	9.3
NC-8219	1"	1-7/16"	27.6 a 221.3	249	4000	311	90	315	9.84	1/2"	103.4	16.7













Incerteza K=0.5a se a ≤ 5 m/s<sup>2</sup> ou K=0.4a se a > 5 m/s<sup>2</sup>

Art No.	ПрисоеА Квадрат	вращательное усилие головки	диапазон вращательного усилия	Макс. Усилие	Скорость свобод. вращения	Среднее потребление воздуха	Рабочее давление воздуха	Общая длина	Вес	Миним. внутр. диаметр шланга	Уровень шума ДБА EN ISO 15744	Уровень вибрации
	дюйм	мм	Нм	Нм	об/мин	л/мин	бар	мм	кг	мм	dBA	m/s <sup>2</sup>
												
NC-6218	3/4"	27	271-1898	2034	6000	182	6.3	320	5.7	13	106	3.3
NC-8212	1"	27	271-1356	1762	6000	170	6.3	235	4.4	13	91.2	5.0
NC-8216	1"	33	271-2170	2441	6000	254	6.3	343	7.0	13	102	9.3
NC-8226	1"	33	271-2170	2441	6000	254	6.3	487	8.4	13	102	9.3
NC-8219	1"	36	271-2170	2441	4000	311	6.3	315	9.84	13	103.4	16.7













Погрешность K=0.5a если a ≤ 5 m/s<sup>2</sup> или K=0.4a если a > 5 m/s<sup>2</sup>

Item No.	Square Drive inch	Bolt Capacity inch	Torque Range FT-LB	Max Torque FT-LB	Free Speed R.P.M	Avg. Air Consumption CFM	Air Pressure PSI	Overall Length inch	Net Weight LBS	Air Hose inch	Sound Pressure Level EN ISO 15744 dBA	Vibration level m/s <sup>2</sup>
Illustrator												
NC-8232	1"	1-7/16"	200-1600	1800	4000	11.0	90	20-13/32"	24.8	1/2"	102	11.5
NC-8311	1"	1-3/8"	200-1600	1800	4000	11.5	90	15"	24.0	1/2"	101	7.3
NC-8351	1"	1-3/8"	200-1600	1800	4000	11.5	90	20"	27.6	1/2"	101	7.3
NC-9223	1-1/2"	2"	200-3000	3500	3000	16.0	90	17-3/4"	42.2	3/4"	104.52	8.86
NC-9243	1-1/2"	2"	200-3000	3500	3000	16.0	90	24-1/4"	50.2	3/4"	104.52	8.86













Uncertainty K=0.5a if a ≤ 5 m/s<sup>2</sup> or K=0.4a if a > 5 m/s<sup>2</sup>

Référence	Carré cond inch	Cap. Boulon mm	Couple recommandé Nm	Couple maxi Nm	Vitesse à vide R.P.M	Cons. D'air moyenne L/min	Pression bar	Longueur mm	Poids kg	Tuyau d'air mm	Niveau sonore EN ISO 15744 dBA	Niveau de vibration m/s <sup>2</sup>
												
NC-8232	1"	36	271-2170	2441	4000	311	6.3	518	11.3	13	102	11.5
NC-8311	1"	33	271-2170	2441	4000	325	6.3	380	10.9	13	101	7.3
NC-8351	1"	33	271-2170	2441	4000	325	6.3	510	12.5	13	101	7.3
NC-9223	1-1/2"	50	271-4065	4746	3000	453	6.3	450	19.7	19	104.52	8.86
NC-9243	1-1/2"	50	271-4065	4746	3000	453	6.3	616	22.8	19	104.52	8.86













Incertitude K=0.5a si a ≤ 5 m/s<sup>2</sup> ou K=0.4a si a > 5 m/s<sup>2</sup>

Artikel-Nr.	Vierecke Antrieb inch	Bolzen Größe mm	Empf. Drehmoment Nm	Max. Drehmoment bei Lösen Nm	Leerlauf Drehzahl R.P.M	Luftverbrauch L/min	Arbeitsdruck bar	Gesamtlänge mm	Nettogewicht kg	Empf. Luftschlauch mm	Schalldruckpegel EN ISO 15744 dBA	Vibrationsniveau m/s <sup>2</sup>
												
NC-8232	1"	36	271-2170	2441	4000	311	6.3	518	11.3	13	102	11.5
NC-8311	1"	33	271-2170	2441	4000	325	6.3	380	10.9	13	101	7.3
NC-8351	1"	33	271-2170	2441	4000	325	6.3	510	12.5	13	101	7.3
NC-9223	1-1/2"	50	271-4065	4746	3000	453	6.3	450	19.7	19	104.52	8.86
NC-9243	1-1/2"	50	271-4065	4746	3000	453	6.3	616	22.8	19	104.52	8.86













Unsicherheit K=0.5 wenn ein ≤ 5 m/s<sup>2</sup> oder K=0.4a wenn a > 5 m/s<sup>2</sup>

Modelo	Matriz Cuadrada	Capacidad de Perno	Rango de Torque	Torque Máximo	Velocidad libre	Consumo de Aire Promedio	Presión de Aire	Longitud Total	Peso Neto	Manguera de Aire	Presión Sonora EN ISO 15744	Nivel de vibración
	inch	mm	Nm	Nm	R.P.M	L/min	bar	mm	kg	mm	dBA	m/s <sup>2</sup>
												
NC-8232	1"	36	200-1600	1800	4000	311	6.3	518	11.3	13	102	11.5
NC-8311	1"	33	200-1600	1800	4000	325	6.3	380	10.9	13	101	7.3
NC-8351	1"	33	200-1600	1800	4000	325	6.3	510	12.5	13	101	7.3
NC-9223	1-1/2"	50	271-4065	4746	3000	453	6.3	450	19.7	19	104.5	8.86
NC-9243	1-1/2"	50	271-4065	4746	3000	453	6.3	616	22.8	19	104.5	8.86

variable K=0.5a si a ≤ 5 m/s<sup>2</sup> ó K=0.4a si a > 5 m/s<sup>2</sup>

Código	Encaixe Quadrado	Capacidade do parafuso	Faixa de Torque	Torque Máximo	Velocidade livre	Consumo de Ar	Pressão de operação	Comprimento Total	Peso	Dímetro interno da mangueira	Nível de ruído EN ISO 15744	Nível de vibração
	polegada	polegada	kgfm	kgfm	R.P.M	L/min	PSI	mm	kg	polegada	dBA	m/s <sup>2</sup>
												
NC-8232	1"	1-7/16"	27.6 a 221.3	249	4000	311	90	518	11.3	1/2"	102	11.5
NC-8311	1"	33	27.6 a 221.3	249	4000	325	90	380	10.9	13	101	7.3
NC-8351	1"	33	27.6 a 221.3	249	4000	325	90	510	12.5	13	101	7.3
NC-9223	1-1/2"	2"	27.6 a 414	483	3000	453	90	450	19.7	3/4"	104.5	8.86
NC-9243	1-1/2"	2"	27.6 a 414	483	3000	453	90	616	22.8	3/4"	104.5	8.86

Incerteza K=0.5a se a ≤ 5 m/s<sup>2</sup> ou K=0.4a se a > 5 m/s<sup>2</sup>

Art No.	ПрисоеА КВАДРАТ	вращательное усилие ГОЕКОВАТО	диапазон вращательного усилия	Макс. Усилие	Скорость свобод. вращения	Среднее потребление воздуха	Рабочее давление воздуха	Общая длина	Вес	Миним. внутр. диаметр шланга	Уровень шума ДБА EN ISO 15744	Уровень вибрации
	дюйм	мм	Нм	Нм	об/мин	л/мин	бар	мм	кг	мм	дБА	m/s <sup>2</sup>
												
NC-8232	1"	36	271-2170	2441	4000	311	6.3	518	11.3	13	102	11.5
NC-8311	1"	33	271-2170	2441	4000	325	6.3	380	10.9	13	101	7.3
NC-8351	1"	33	271-2170	2441	4000	325	6.3	510	12.5	13	101	7.3
NC-9223	1-1/2"	50	271-4065	4746	3000	453	6.3	450	19.7	19	104.5	8.86
NC-9243	1-1/2"	50	271-4065	4746	3000	453	6.3	616	22.8	19	104.5	8.86

Погрешность K=0.5a если a ≤ 5 m/s<sup>2</sup> или K=0.4a если a > 5 m/s<sup>2</sup>





## EC DECLARATION OF CONFORMITY

**Original Language**

**Serial Number:** Please refer to the tool

**Air Impact Wrench**

**Item No.:** NC-6218 NC-8212 NC-8216 NC-8226 NC-8219 NC-8232 NC-8351 NC-8311  
NC-9223 NC-9243

We declare under our own responsibility that the above machinery fulfils all the relevant provisions of (MD) Machinery Directive 2006/42/EC and its amendment and is manufactured and tested according to the following standards:  
EN ISO 11148-6 / EN ISO 15744 / EN ISO 28927-2

Declared in: Taichung, Taiwan

Dated:2016/05/01

**Signature**

Jonney Chen

Declared by: QA Manager



**Manufacturer:**

**Mighty Seven International Co., Ltd.**

No. 70-25, Ching Quang Rd., Wujih Dist.,

Taichung City, 41466 Taiwan

<http://www.mighty-seven.com>

Authorized contact, to compile the technical files :

**King Tony France**

3 Rue des imprimeurs ZI République Nord 1.

86000 POITIERS FRANCE

TEL : (+33) 5-49-30-30-90

E-MAIL : [christian.aubineau@kingtony.eu](mailto:christian.aubineau@kingtony.eu)



## EC-DECLARATION DE CONFORMITE

traduit de la langue originale

Numéro de série : se référer au numéro inscrit sur la machine

Clé à chocs

Référence: NC-6218 NC-8212 NC-8216 NC-8226 NC-8219 NC-8232 NC-8351 NC-8311  
NC-9223 NC-9243

Nous déclarons sous notre propre responsabilité que les outils sus mentionnés sont conforme aux provisions relative à la directive outillage 2006/42/EC et ses amendements

et qu'ils ont été fabriqués et testés selon les standards suivants :

EN ISO 11148-6 / EN ISO 15744 / EN ISO 28927-2

Déclaré à: Taichung, Taiwan

Date: 2016/05/01

**Signature**

Jonney Chen

Declared by: QA Manager



**Fabricant:**

**Mighty Seven International Co., Ltd.**

No. 70-25, Ching Quang Rd., Wujih Dist.,

Taichung City, 41466 Taiwan

<http://www.mighty-seven.com>

Personne autorisée pour établir les fiches techniques:

**King Tony France**

3 Rue des imprimeurs ZI République Nord 1. 86000 POITIERS

FRANCE

TEL : (+33) 5-49-30-30-90

E-MAIL : [christian.aubineau@kingtony.com](mailto:christian.aubineau@kingtony.com)



## EG-Konformitätserklärung

Übersetzung aus der Original-Sprache

Seriennummer: bitte bei Frage immer angeben!

Druckluft-Schlagschrauber

Artikel-Nr. NC-6218 NC-8212 NC-8216 NC-8226 NC-8219 NC-8232 NC-8351 NC-8311  
NC-9223 NC-9243

Wir erklären in eigener Verantwortung, dass folgendes Produkt alle einschlägigen Bestimmungen der Maschinen-Richtlinie 2006/42/EC erfüllt und deren Änderungen, und dass es hergestellt wird und nach den folgenden Normen geprüft wird:

EN ISO 11148-6 / EN ISO 15744 / EN ISO 28927-2

Erklärt in: Taichung, Taiwan

Datum: 2016/05/01

**Unterschrift:**

Jonney Chen

Erklärt von: QA Manager



**Der Hersteller:**

**Mighty Seven International Co., Ltd.**

No. 70-25, Ching Quang Rd., Wujih Dist.,

Taichung City, 41466 Taiwan

<http://www.mighty-seven.com>

Autorisierte Person, die zur Erstellung des technischen  
Dossiers ist :

**King Tony France**

3 Rue des imprimeurs ZI République Nord 1.

86000 POITIERS FRANCE

TEL : (+33) 5-49-30-30-90

E-MAIL : [christian.aubineau@kingtony.eu](mailto:christian.aubineau@kingtony.eu)



## DECLARACIÓN DE CONFORMIDAD DE EC

Traducción del lenguaje original

Número de serie: por favor ver la herramienta

Llave de Impacto Neumática

Modelo : NC-6218 NC-8212 NC-8216 NC-8226 NC-8219 NC-8232 NC-8351 NC-8311  
NC-9223 NC-9243

Declaramos bajo nuestra propia responsabilidad que la maquinaria arriba mencionada cumple con todas las provisiones relevantes de la Directiva de Maquinaria 2006/42/EC y sus enmiendas y ha sido fabricado y probado de acuerdo a los siguientes estándares:

EN ISO 11148-6 / EN ISO 15744 / EN ISO 28927-2

Declarado en: Taichung, Taiwan

Fecha: 2016/05/01

**Firma**

Jonney Chen

Declarado por: Gerente de Control de Calidad



**Fabricante:**

**Mighty Seven International Co., Ltd.**

No. 70-25, Ching Quang Rd., Wujih Dist.,

Taichung City, 41466 Taiwan

<http://www.mighty-seven.com>

Contacto Autorizado, para recopilar los archivos técnicos :

**King Tony France**

3 Rue des imprimeurs ZI République Nord 1. 86000 POITIERS

FRANCE

TEL : (+33) 5-49-30-30-90

E-MAIL : [christian.aubineau@kingtony.eu](mailto:christian.aubineau@kingtony.eu)



## Declaração de Conformidade EC

tradução da língua original

número de série: por favor, procure-o na ferramenta

Chave de impacto pneumática

Código: NC-6218 NC-8212 NC-8216 NC-8226 NC-8219 NC-8232 NC-8351 NC-8311  
NC-9223 NC-9243

Declaramos bajo nuestra propia responsabilidad que la maquinaria arriba mencionada cumple con todas las provisiones relevantes de la Directiva de Maquinaria 2006/42/EC y sus enmiendas y ha sido fabricado y probado de acuerdo a los siguientes estándares:

EN ISO 11148-6 / EN ISO 15744 / EN ISO 28927-2

Declarada em: Taichung, Taiwan

Datada de: 2016/05/01

**Assinada por**

Jonney Chen

Declarada pelo Gerente da Qualidade



**Fabricante:**

**Mighty Seven International Co., Ltd.**

No. 70-25, Ching Quang Rd., Wujih Dist.,

Taichung City, 41466 Taiwan

<http://www.mighty-seven.com>

Contato responsável pelas informações técnicas:

**King Tony France**

3 Rue des imprimeurs ZI République Nord 1. 86000 POITIERS

FRANCE

TEL : (+33) 5-49-30-30-90

E-MAIL : [christian.aubineau@kingtony.eu](mailto:christian.aubineau@kingtony.eu)



## Декларация соответствия стандарту ЕС

Перевод с языка оригинала

серийный номер: смотрите на инструменте

Пневмогайковёрт ударный

Арт No.: NC-6218 NC-8212 NC-8216 NC-8226 NC-8219 NC-8232 NC-8351 NC-8311  
NC-9223 NC-9243

Мы удостоверяем, что данное оборудование соответствует следующим нормам качества 2006/42/ЕС и все технологические изменения конструкции и производства были подвергнуты испытаниям и сертифицированы по следующим стандартам качества:

EN ISO 11148-6 / EN ISO 15744 / EN ISO 28927-2

Удостоверено в: Taichung, Taiwan

Дата:2016/05/01

*Подпись*

Jonney Chen

Начальник службы технического контроля

*Производитель*

**Mighty Seven International Co., Ltd.**

No. 70-25, Ching Quang Rd., Wujih Dist.,

Taichung City, 41466 Taiwan

<http://www.mighty-seven.com>



Официальный представитель, представляющий  
техническую документацию

**King Tony France**

3 Rue des imprimeurs ZI République Nord 1. 86000 POITIERS  
FRANCE

TEL : (+33) 5-49-30-30-90

E-MAIL : [christian.aubineau@kingtony.com](mailto:christian.aubineau@kingtony.com)



## Deklaracja zgodności CE

tłumaczenie w języku miejscowym

numer seryjny: proszę odwołać się do narzędzi

**Klucz udarowy**

Pozycja nr.: NC-6218 NC-8212 NC-8216 NC-8226 NC-8219 NC-8232 NC-8351 NC-8311  
NC-9223 NC-9243

Oświadczamy na własną odpowiedzialność, że wyżej wymieniona maszyna jest zgodna z wszystkimi stosownymi przepisami Dyrektywy dla maszyn 2006/42/EC oraz Jej zmianami oraz jest wyprodukowana i przebadana zgodnie z następującymi normami: EN ISO 11148-6 / EN ISO 15744 / EN ISO 28927-2

Wystawiono w: Taichung, Taiwan  
data: 2016/05/01

**podpis**

Jonney Chen  
Poświadczca: QA Manager

**Producent**

**Mighty Seven International Co., Ltd.**

No. 70-25, Ching Quang Rd., Wujih Dist.,

Taichung City, 41466 Taiwan

<http://www.mighty-seven.com>

Autoryzowany kontakt do skompletowania dokumentacji  
technicznej:

**King Tony France**

3 Rue des imprimeurs ZI République Nord 1. 86000 POITIERS  
FRANCE

TEL : (+33) 5-49-30-30-90

E-MAIL : [christian.aubineau@kingtony.eu](mailto:christian.aubineau@kingtony.eu)



# 3/4" Air Impact Wrench

Item No : NC-6218

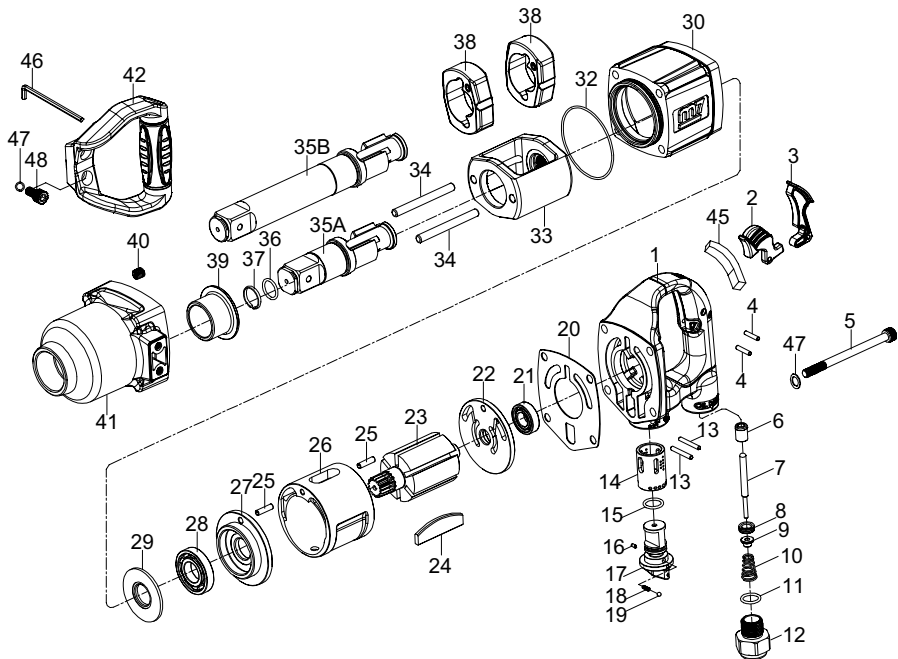



# Part List

## Twin Hammer Type

NC-6218



NO.	PART NO.	DESCRIPTION	Q'TY
1	NC-6218T01	Backhead Assembly (01.06.14)	1 Set
2	NC-6218P02	Inside Trigger	1
3	NC-6218P03	Outside Trigger	1
4	NC-6218T04	Pin (2 PCS)	1 Set
5	NC-6218T05	Screw (4 PCS)	1 Set
6	---	Bushing	1
7	NC-6218P07	Throttle Valve Plunger	1
8	NC-6218P08	Throttle Valve Seat	1
9	NC-6218P09	Throttle Valve	1
10	NC-6218P10	Spring	1
11	NC-6218P11	O-Ring	1
12	NC-6218P12	Air Inlet	1
13	NC-6218T13	Spring Pin (2 PCS)	1 Set
14	---	Reverse Valve Bushing	1
15	NC-6218P15	O-Ring	1
16	NC-6218P16	Spring Pin	1
17	NC-6218P17	Reverse Valve	1
18	NC-6218P18	Spring	1
19	NC-6218P19	Steel Ball	1
20	NC-6218P20	Gasket	1
21	NC-6218P21	Ball Bearing	1
22	NC-6218P22	Rear End Plate	1
23	NC-6218P23	Rotor	1

NO.	PART NO.	DESCRIPTION	Q'TY
24	NC-6218T24	Rotor Blade (6 PCS)	1 Set
25	NC-6218T25	Spring Pin (2 PCS)	1 Set
26	NC-6218P26	Cylinder	1
27	NC-6218P27	Front End Plate	1
28	---	Ball Bearing	1
29	NC-6218P29	Washer	1
30	NC-6218P30	Motor Housing	1
32	NC-6218P32	O-Ring	1
33	NC-6218P33	Hammer Cage	1
34	NC-6218T34	Hammer Pin (2 PCS)	1 Set
35A	NC-6218T35A	Standard Anvil (35A.36.37)	1 Set
35B	NC-6218T35B	6" Extend Anvil (35B.36.37)	1 Set
36	---	O-Ring	1
37	---	Socket Retainer	1
38	NC-6218T38	Hammer (2 PCS)	1 Set
39	NC-6218P39	Anvil Bushing	1
40	---	Heli-Coil (4 PCS)	1 Set
41	NC-6218T41	Clutch Housing Ass'y (39,40,41)	1 Set
42	NC-6218P42	Side Spade Handle	1
45	NC-6218P45	Rubber Cap (for inside Trigger)	1
46	NC-6218P46	Hex Key Wrench	1
47	NC-6218T47	Washer (6 PCS)	1 Set
48	NC-6218T48	Screw (2 PCS)	1 Set
49	NC-6218T27	Front End Plate Ass'y (27,28)	1 set



# 1" Air Impact Wrench

Item No : NC-8212

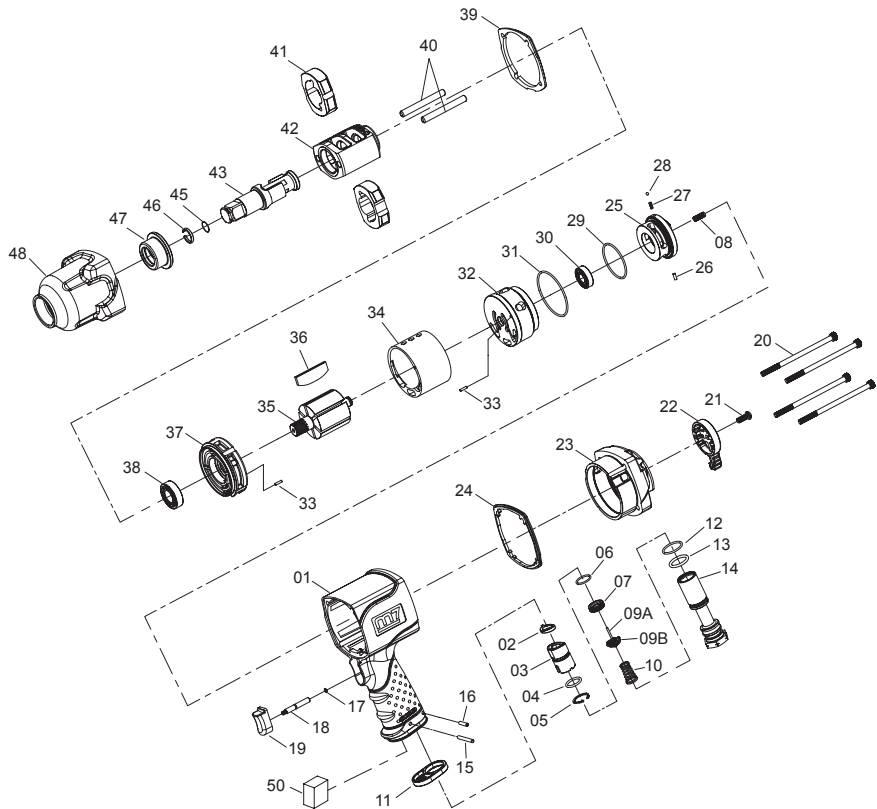

# Part List New Twin Hammer Type

NC-8212

NO.	PART NO.	DESCRIPTION	Q'ty
01	NC-8212T01	Motor Housing Ass'y (01.02.03)	1 set
02	---	O-Ring	1
03	---	Guide Tube	1
04	NC-8212P04	O-Ring	1
05	NC-8212P05	Retainer	1
06	NC-8212P06	O-Ring	1
07	NC-8212P07	Throttle Valve Seal	1
08	NC-8212P08	Heli Coil	1
09A	---	Throttle Valve Pin	1
09B	---	Throttle Valve	1
10	NC-8212P10	Spring	1
11	NC-8212P11	Exhaust Deflector	1
12	NC-8212P12	O-Ring	1
13	NC-8212P13	O-Ring	1
14	NC-8212P14	Air Inlet	1
15	NC-8212P15	Spring Pin	1
16	NC-8212P16	Spring Pin	1
17	NC-8212P17	O-Ring	1
18	---	Trigger Pin	1
19	---	Trigger	1
20	NC-8212T20	Screw (4pcs)	1 set
21	NC-8212P21	Screw	1
22	NC-8212P22	Reverse Valve Knob	1
23	NC-8212P23	Backhead	1
24	NC-8212P24	Rear Gasket	1
25	NC-8212P25	Reverse Valve	1
26	NC-8212P26	Spring Pin	1
27	NC-8212P27	Spring	1

NO.	PART NO.	DESCRIPTION	Q'ty
29	---	O-Ring	1
30	---	Ball Bearing	1
31	---	O-Ring	1
32	---	Rear End Plate	1
33	NC-8212T33	Spring Pin (2pcs)	1 set
34	NC-8212P34	Cylinder	1
35	NC-8212P35	Rotor	1
36	NC-8212T36	Rotor Blade (6pcs)	1 set
37	NC-8212P37	Front End Plate	1
38	NC-8212P38	Ball Bearing	1
39	NC-8212P39	Front Gasket	1
40	NC-8212T40	Hammer Pin (2pcs)	1 set
41	NC-8212T41	Hammer (2pcs)	1 set
42	NC-8212P42	Hammer Cage	1
43	NC-8212T43	Anvil Ass'y (43.45.46)	1 set
45	---	O-Ring	1
46	---	Socket Retainer	1
47	---	Anvil Bushing	1
48	---	Clutch Housing	1
50	NC-8212P50	Muffler Element	1
	NC-8212T01	Motor Housing Ass'y (01.02.03)	1 set
	NC-8212T02	Throttle Valve Ass'y (09A.09B)	1 set
	NC-8212T03	Trigger Ass'y (18.19)	1 set
	NC-8212T04	Rear End Plate Ass'y (08.23.25.26.27.28.29.30.3132)	1 set
	NC-8212T05	Hammer Case Ass'y (47.48)	1 set
	NC-8212T43	Anvil Ass'y (43.45.46)	1 set



# 1" Air Impact Wrench

Item No : NC-8216 / NC-8226

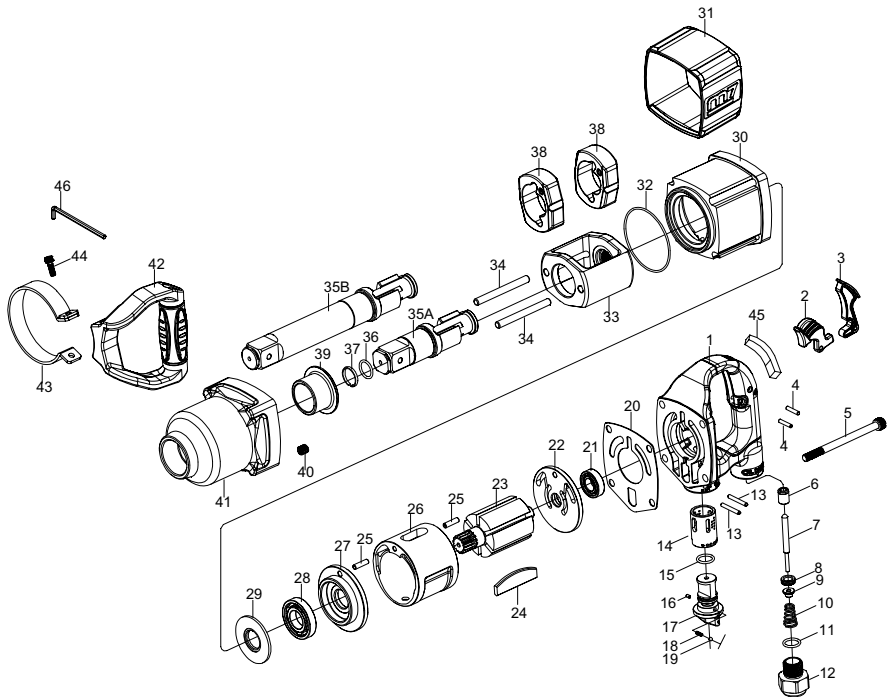

# Part List

## Twin Hammer Type

NC-8216 / NC-8226



NO.	INDEX NO.	DESCRIPTION	QTY
1	NC-8216T01	Backhead Ass'y (1,6,14)	1set
2	NC-8216P02	Inside Trigger	1
3	NC-8216P03	Outside Trigger	1
4	NC-8216T04	Pin (2 PCS)	1set
5	NC-8216T05	Screw (4 PCS)	1set
6	-	Bushing	1
7	NC-8216P07	Throttle Valve Plunger	1
8	NC-8216P08	Throttle Valve Seat	1
9	NC-8216P09	Throttle Valve	1
10	NC-8216P10	Spring	1
11	NC-8216P11	O-Ring	1
12	NC-8216P12	Air Inlet	1
13	NC-8216T13	Spring Pin (2 PCS)	1set
14	-	Reverse Valve Bushing	1
15	NC-8216P15	O-Ring	1
16	NC-8216T16	Spring Pin (2 PCS)	1set
17	NC-8216P17	Reverse Valve	1
18	NC-8216P18	Steel Ball	1
19	NC-8216P19	Spring	1
20	NC-8216P20	Gasket	1
21	NC-8216P21	Ball Bearing	1
22	NC-8216P22	Rear End Plate	1
23	NC-8216P23	Rotor	1
24	NC-8216T24	Rotor Blade (6 PCS)	1set
25	NC-8216T25	Spring Pin (2 PCS)	1set
26	NC-8216P26	Cylinder	1
27	NC-8216P27	Front End Plate	1
28	NC-8216P28	Ball Bearing	1
29	NC-8216P29	Washer	1
30	NC-8216P30	Motor Housing	1

NO.	INDEX NO.	DESCRIPTION	QTY
31	NC-8216P31	Rubber Grip	1
32	NC-8216P32	O-Ring	1
33	NC-8216P33	Hammer Cage	1
34	NC-8216T34	Hammer Pin (2 PCS)	1set
35A	NC-8216T35A	Standard Anvil Ass'y (35A,36,37)	1set
35B	NC-8216T35B	6" Extended Anvil for NC-8226 (35B,36,37)	1set
36	NC-8216P36	O-Ring	1
37	NC-8216P37	Socket Retainer	1
38	NC-8216T38	Hammer (2 PCS)	1set
39	-	Anvil Bushing	1
40	-	Heli-Coil (4 PCS)	1set
41	NC-8216T41	Clutch Housing Ass'y (39,40,41)	1set
42	NC-8216T42	Side Spade Handle Ass'y (42,43)	1set
43	-	Strap	1
44	NC-8216T44	Screw (2 PCS)	1set
45	NC-8216P45	Rubber Cap (for Inside Trigger)	1
46	NC-8216P46	Hex Key Wrench	1
	NC-8216T02	Standard Anvil Ass'y(35A,36,37)	1set
	NC-8216T03	6"Extended Anvil Ass'y (35B,36,37) for NC-8226	1set
	NC-8216T22	Rear End Plate Ass'y (21,22)	1 set
	NC-8216T27	Front End Plate Ass'y (27,28)	1 set



# 1" Air Impact Wrench

Item No : NC-8219

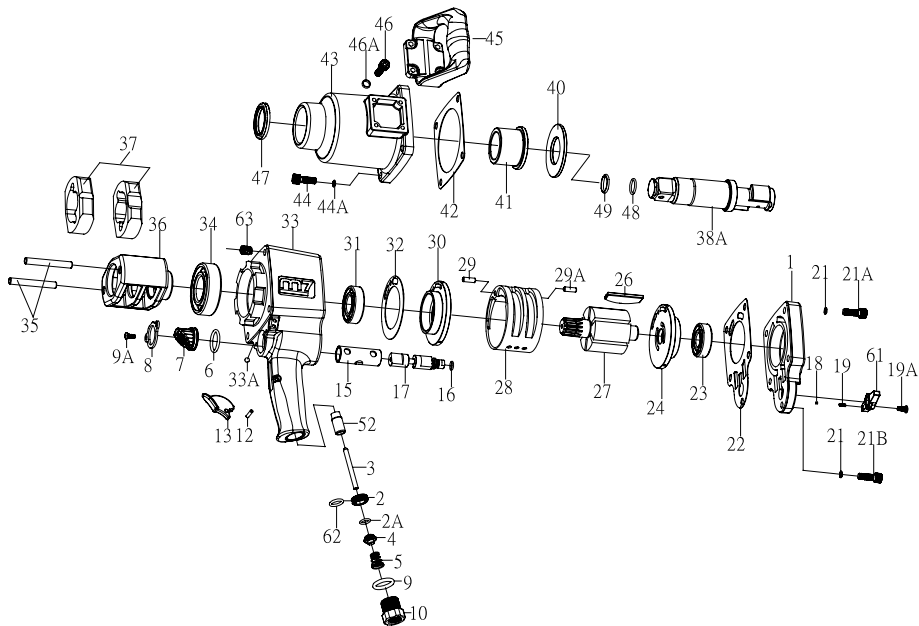

# Part List New Twin Hammer Type

**NC-8219**

NO.	INDEX NO.	DESCRIPTION	Q'ty
1	NC-8219P01	Backhead	1
2	NC-8219P02	Throttle Valve Seat	1
2A	NC-8219P02A	O-Ring	1
3	NC-8219P03	Throttle Valve Plunger	1
4	NC-8219P04	Throttle Valve	1
5	NC-8219P05	Spring	1
6	NC-8219P06	O-Ring	1
7	NC-8219P07	Exhaust Deflector	1
8	NC-8219P08	Retainer	1
9	NC-8219P09	O-Ring	1
9A	NC-8219T09A	Screw (2 pcs)	1set
10	NC-8219P10	Air Inlet	1
12	NC-8219P12	Trigger Pin	1
13	NC-8219P13	Trigger	1
15	---	Reverse Valve Bushing	1
16	NC-8219P16	O-Ring	1
17	NC-8219P17	Reverse Valve	1
18	NC-8219P18	Steel Ball	1
19	NC-8219P19	Spring	1
19A	NC-8219P19A	Screw	1
21	---	Spring Washer (4 pcs)	1set
21A	NC-8219T21A	Screw Assembly 4pcs(21A,21)	1set
21B	NC-8219T21B	Screw Assembly (21B,21)	1set
22	NC-8219P22	Gasket	1
23	---	Ball Bearing	1
24	NC-8219T24	Rear End Plate Assembly (23,24)	1set
26	NC-8219T26	Rotor Blade (6pcs)	1set
27	NC-8219P27	Rotor	1
28	NC-8219P28	Cylinder	1
29	NC-8219P29	Spring Pin	1

NO.	INDEX NO.	DESCRIPTION	Q'ty
29A	NC-8219P29A	Spring Pin	1
30	NC-8219T30	Front End Plate Assembly (30,31)	1set
31	---	Ball Bearing	1
32	NC-8219P32	Gasket	1
33	NC-8219T33	Motor Housing Assembly (15,33,33A,52,63)	1set
33A	---	Steel Ball (4pcs)	1set
34	NC-8219P34	Ball Bearing	1
35	NC-8219T35	Hammer Pin (2pcs)	1set
36	NC-8219P36	Hammer Cage	1
37	NC-8219T37	Hammer (2pcs)	1set
38A	NC-8219T38A	Standard Anvil 38A,48,49	1set
40	NC-8219P40	Washer	1
41	NC-8219P41	Anvil Bushing	1
42	NC-8219P42	Gasket	1
43	NC-8219P43	Clutch Housing	1
44	NC-8219T44	Screw Assembly (4pcs) (44,44A)	1set
44A	-	Spring Washer (4pcs)	1set
45	NC-8219P45	Side Spade Handle	1
46	NC-8219T46	Screw (4pcs) (46,46A)	1set
46A	---	Spring Washer (4pcs)	1set
47	NC-8219P47	Oil Seal	1
48	NC-8219P48	O-Ring	1
49	NC-8219P49	Socket Retainer	1
52	---	Bushing	1
61	NC-8219P61	Reverse Valve Knob	1
62	NC-8219P62	O-Ring	1
63	---	Heli-Coil (9pcs)	1set



# 1" Air Impact Wrench

Item No : NC-8311 NC8351

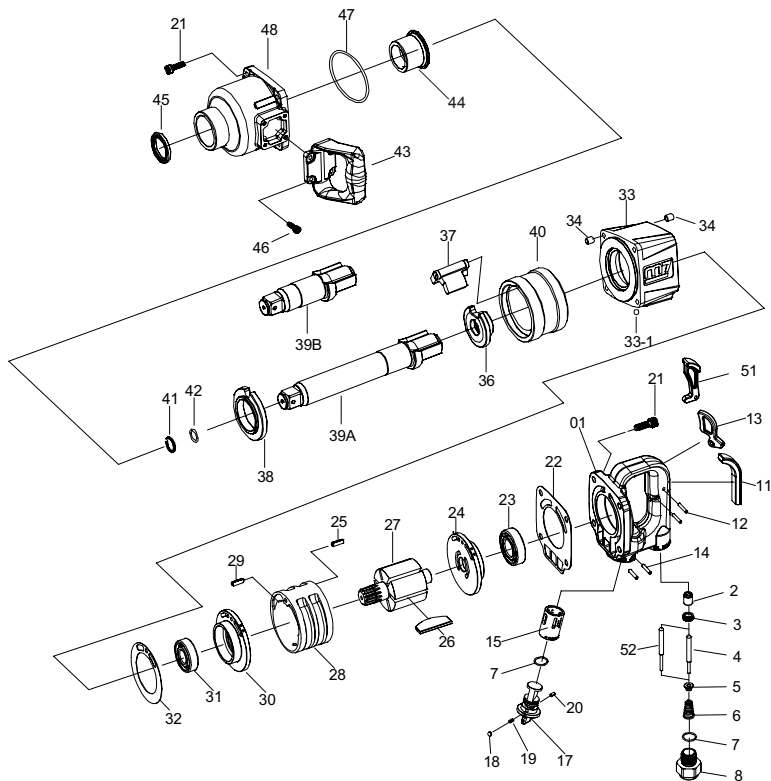



# Part List

## Pin Less Type

### NC-8311-8351

NO.	PART NO.	DESCRIPTION	Q'ty
1	NC-8311T01	Backhead Ass'y (1, 2, 15)	1set
2	---	Bushing	1
3	NC-8311P03	Throttle Valve Seat	1
4	NC-8311P04	Throttle Valve Plunger (For Inside Trigger)	1
5	NC-8311P05	Throttle Valve	1
6	NC-8311P06	Spring	1
7	NC-8311T07	O-Ring (2 PCS)	1set
8	NC-8311P08	Straight Air Inlet	1
11	NC-8311P11	Rubber Cap (For Inside Trigger)	1
12	NC-8311T12	Pin (2 PCS)	1set
13	NC-8311P13	Inside Trigger	1
14	NC-8311T14	Spring Pin (2 PCS)	1set
15	---	Reverse Valve Bushing	1
17	---	Reverse Valve	1
18	NC-8311P18	Steel Ball	1
19	NC-8311P19	Spring	1
20	---	Spring Pin	1
21	NC-8311T21	Screw (8 PCS)	1set
22	NC-8311P22	Gasket	1
23	---	Ball Bearing	1
24	---	Rear End Plate	1
25	NC-8311P25	Spring Pin	1
26	NC-8311T26	Rotor Blade (6 PCS)	1set
27	NC-8311P27	Rotor	1
28	NC-8311P28	Cylinder	1
29	NC-8311P29	Spring Pin	1
30	---	Front End Plate	1
31	---	Ball Bearing	1

NO.	PART NO.	DESCRIPTION	Q'ty
32	NC-8311P32	Gasket	1
33	---	Motor Housing	1
33-1	---	Steel Ball (4 PCS)	1set
34	---	Heli-Coil (8 PCS)	1set
36	NC-8311P36	Cam	1
37	NC-8311P37	Hammer	1
38	NC-8311P38	Axle Bushing	1
39A	---	6" Extend Anvil for NC-8351	1
39B	---	Standard Anvil for NC-8311	1
40	NC-8311P40	Hammer Frame	1
41	---	Socket Retainer	1
42	---	O-Ring	1
43	NC-8311P43	Side Spade Handle	1
44	NC-8311P44	Anvil Bushing	1
45	NC-8311P45	Oil Seal	1
46	NC-8311T46	Screw (4 PCS)	1set
47	NC-8311P47	O-Ring	1
48	NC-8311P48	Clutch Housing	1
51	NC-8311P51	Outside Trigger	1
52	NC-8311P52	Throttle Valve Plunger	1
	NC-8311T02	Reverse Valve Ass'y (17, 20)	1set
	NC-8311T03	Rear End Plate Ass'y (23, 24)	1set
	NC-8311T04	Front End Plate Ass'y (30, 31)	1set
	NC-8311T05	Housing Ass'y {33, 33-1(4), 34(8)}	1set
	NC-8311T06A	6" Extend Anvil Ass'y {39A, 41, 42} (for NC-8351)	1set
	NC-8311T06B	Standard Anvil Ass'y {39B, 41, 42}	1set



# 1" Air Impact Wrench

Item No : NC-8232

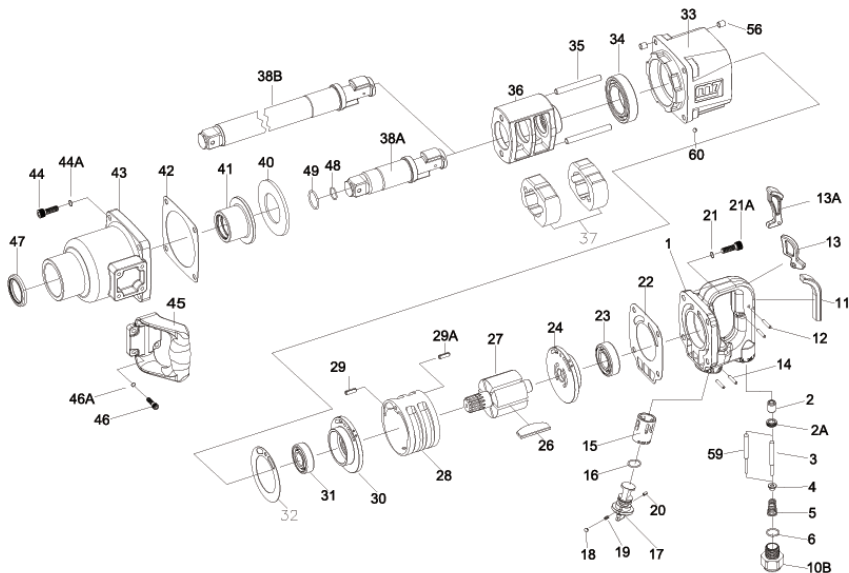

# Part List

## New Twin Hammer Type

NC-8232



NO.	PART NO.	DESCRIPTION	Q'TY
1	NC-8232T01	Backhead Assembly (01,02,15)	1 SET
2	---	Bushing	1
2A	NC-8232P02A	Throttle Valve Seat	1
3	NC-8232P03	Throttle Valve Plunger ( for Inside Trigger )	1
4	NC-8232P04	Throttle Valve	1
5	NC-8232P05	Spring	1
6	NC-8232P06	O-Ring	1
10B	NC-8232P10B	Air Inlet ( Option )	1
11	NC-8232P11	Rubber Cap ( for Inside Trigger )	1
12	NC-8232T12	Pin (2 PCS)	1 SET
13	NC-8232P13	Inside Trigger ( Option )	1
13A	NC-8232P13A	Outside Trigger ( Option )	1
14	NC-8232T14	Spring Pin (2 PCS)	1 SET
15	---	Reverse Valve Bushing	1
16	NC-8232P16	O-Ring	1
17	---	Reverse Valve	1
18	NC-8232P18	Steel Ball	1
19	NC-8232P19	Spring	1
20	---	Spring Pin	1
21	---	Spring Washer (4 PCS)	1 SET
21A	---	Screw (4 PCS)	1 SET
22	NC-8232P22	Gasket	1
23	---	Ball Bearing	1
24	---	Rear End Plate	1
26	NC-8232T26	Rotor Blade (6 PCS)	1 SET
27	NC-8232P27	Rotor	1
28	NC-8232P28	Cylinder	1
29	NC-8232P29	Spring Pin	1
29A	NC-8232P29A	Spring Pin	1
30	---	Front End Plate	1
31	---	Ball Bearing	1
32	NC-8232P32	Gasket	1

NO.	PART NO.	DESCRIPTION	Q'TY
33	---	Motor Housing	1
34	NC-8232P34	Ball Bearing	1
35	NC-8232T35	Hammer Pin (2 PCS)	1 SET
36	NC-8232P36	Hammer Cage	1
37	NC-8232T37	Hammer (2 PCS)	1 SET
38A	NC-8232T38A	Standard Anvil (38A,48,49)	1 SET
38B	NC-8232T38B	6" Extended Anvil (38B,48,49 ) For NC-8232	1 SET
40	NC-8232P40	Washer	1
41	NC-8232P41	Anvil Bushing	1
42	NC-8232P42	Gasket	1
43	NC-8232P43	Clutch Housing	1
44	---	Screw (4 PCS)	1 SET
44A	---	Spring Washer (4 PCS)	1 SET
45	NC-8232P45	Side Spade Handle	1
46	---	Screw (4 PCS)	1 SET
46A	---	Spring Washer (4 PCS)	1 SET
47	NC-8232P47	Oil Seal	1
48	---	O-Ring	1
49	---	Socket Retainer	1
52	NC-8232P52	Lock Nut ( Option )	1
53	NC-8232P53	Air Inlet ( Option )	1
56	---	Heil-Coil (8 PCS)	1 SET
59	NC-8232P59	Throttle Valve Plunger ( for Outside Trigger )	1
60	---	Steel Ball (4 PCS)	1 SET
	NC-8232T02	Reverse Valve Assembly (17,20)	1 SET
	NC-8232T03	Screw Assembly (21,21A)	1 SET
	NC-8232T04	Rear End Plate Assembly (23,24)	1 SET
	NC-8232T05	Front End Plate Assembly (30,31)	1 SET
	NC-8232T06	Motor Housing Assembly (33,56,60)	1 SET
	NC-8232T07	Screw Assembly (44,44A)	1 SET
	NC-8232T08	Screw Assembly (46,46A)	1 SET



# 1-1/2" Air Impact Wrench

Item No : NC-9223 NC-9243

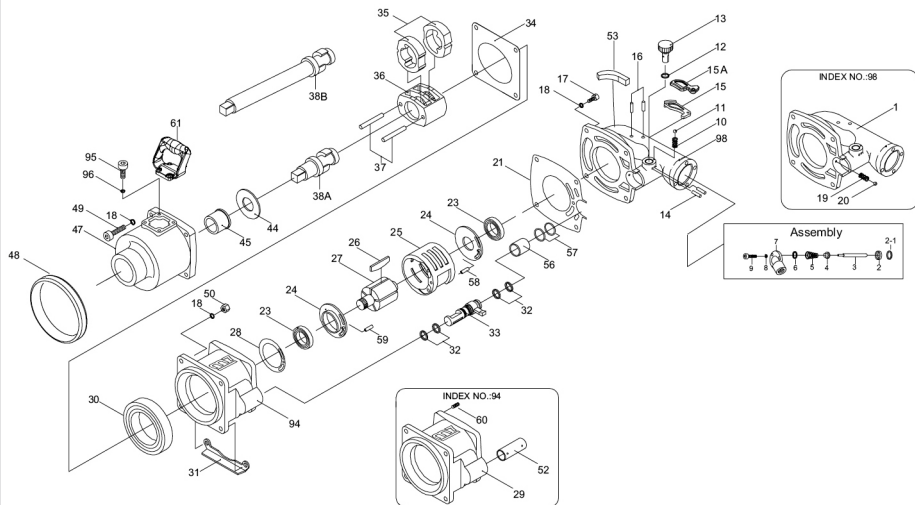

# Part List

## New Twin Hammer Type

NC-9223-9243



NO.	INDEX NO.	DESCRIPTION	Q'TY	NO.	INDEX NO.	DESCRIPTION	Q'TY
1	---	Backhead	1	29	---	Motor Housing	1
2	NC-9223P02	Throttle Valve Seat	1	30	NC-9223P30	Ball Bearing	1
2-1	NC-9223P02-1	Throttle Valve Washer	1	31	NC-9223P31	Motor Housing Protector	1
3	NC-9223P03	Throttle Valve Plunger	1	32	NC-9223T32	O-Ring (4 PCS)	1 SET
4	NC-9223P04	Throttle Valve	1	33	NC-9223P33	Reverse Valve	1
5	NC-9223P05	Spring	1	34	NC-9223P34	Gasket	1
6	NC-9223P06	O-Ring	1	35	NC-9223T35	Hammer (2 PCS)	1 SET
7	NC-9223T07	Air Inlet Ass'y (2.2-1.3.4.5.6.7.8.9)	1 SET	36	NC-9223P36	Hammer Cage	1
8	NC-9223T08	Spring Washer (4 PCS)	1 SET	37	NC-9223T37	Hammer Pin (2 PCS)	1 SET
9	NC-9223T09	Screw Ass'y (4 PCS)	1 SET	38A	NC-9223P38A	Standard Anvil	1
10	NC-9223P10	Spring	1	38B	NC-9223P38B	8" Extended Anvil	1
11	NC-9223P11	Steel Ball	1	44	NC-9223P44	Washer	1
12	NC-9223P12	O-Ring	1	45	NC-9223P45	Bushing	1
13	NC-9223P13	Air Regulator	1	47	NC-9223P47	Clutch Housing	1
14	NC-9223T14	Spring Pin (2 PCS)	1 SET	48	NC-9223P48	Shield Housing Nose	1
15	NC-9223P15	Outside Trigger	1	49	NC-9223T49	Screw Ass'y (4 PCS)	1 SET
15A	NC-9223P15A	Inside Trigger	1	50	NC-9223T50	Lock Nuts (4 PCS)	1 SET
16	NC-9223T16	Spring Pin (2 PCS)	1 SET	52	---	Reverse Valve Bushing	1
17	NC-9223T17	Screw Ass'y (4 PCS)	1 SET	53	NC-9223P53	Rubber Cap	1
18	NC-9223P18	Spring Washer	1	56	NC-9223P56	Bushing	1
19	---	Spring	1	57	NC-9223T57	O-Ring (2 PCS)	1 SET
20	---	Steel Ball	1	58	NC-9223P58	Spring Pin	1
21	NC-9223P21	Gasket	1	59	NC-9223P59	Spring Pin	1
23	NC-9223P23	Ball Bearing	1	60	---	Heli-Coil (4 PCS)	1 SET
24	NC-9223P24	Rear& Front End Plate	1	61	NC-9223P61	Side Spade Handle	1
25	NC-9223P25	Cylinder	1	94	NC-9223T94	Motor Housing Ass'y (29.52.60)	1 SET
26	NC-9223T26	Rotor Blade (7 PCS)	1 SET	95	NC-9223T95	Screw Ass'y (4 PCS)(95.96)	1 SET
27	NC-9223P27	Rotor	1	96	---	Spring Washer (4 PCS)	1 SET
28	NC-9223P28	Gasket	1	98	NC-9223T98	Backhead Ass'y (1.19.20)	1 SET

# Warranty Card

## Manufacturer's limited warranty

**Mighty Seven International CO., LTD.** offers limited warranty to the products manufactured by **Mighty Seven** and sold by its worldwide authorized dealers. The limited warranty only applies to products that are defective in material and workmanship and does not apply to products which have been abused, misused, modified, or repaired by someone other than **Mighty Seven** or its authorized service representatives. If there is a defective product of **Mighty Seven**, please send it prepaid to the dealer where it was purchased from along with address and contact information. Repairs or replacements are warranted as described above; otherwise, the service of repairs or replacements will be charged.

Please Keep This card For Warranty

Date of Purchase :	Model No. :
Warranty Expiration Date :	Serial No. :
<b>Distributor Stamp</b>  	



For Distributor

## Warranty Card

Date of Purchase :	Model No. :
Warranty Expiration Date :	Serial No. :
Name :	
Company Name :	
Address :	
Tel. :	Fax. :
E-mail :	
<b>Type of Business :</b>	
<input type="checkbox"/> Agriculture	<input type="checkbox"/> Paint & Body Repair
<input type="checkbox"/> General Auto Repair	<input type="checkbox"/> Public Work/Gov. Utilities
<input type="checkbox"/> Tire	<input type="checkbox"/> Factory
<input type="checkbox"/> Truck Maintenance/Repair	<input type="checkbox"/> Home Use
<input type="checkbox"/> Car Maker	<input type="checkbox"/> Other _____
<b>Specification of compressor used :</b>	
Horsepower :	Tank Size (liter/gal) :
<input type="checkbox"/> 5 <input type="checkbox"/> 7.5 <input type="checkbox"/> 10 <input type="checkbox"/> 15+	<input type="checkbox"/> 75.7(20) <input type="checkbox"/> 227.1 (60) <input type="checkbox"/> 302.8(80) <input type="checkbox"/> 454.2(120)
<input type="checkbox"/> other _____	<input type="checkbox"/> other _____

# Formulaire de garantie

## Garantie fabricant

**Mighty Seven International CO., LTD** offre la garantie fabricant aux produits fabriqués par **Mighty Seven** et vendus par ses distributeurs agréés dans le monde entier. La garantie limitée s'applique seulement aux produits qui sont défectueux et ne s'applique pas aux produits qui ont été mal utilisés, perdus, modifiés ou réparés par quelqu'un d'autre que **Mighty Seven** ou ses services techniques. S'il y a un produit défectueux de **Mighty Seven**, envoyez-le au distributeur où il a été acheté, avec l'adresse et les coordonnées du propriétaire. La réparation ou les remplacements de pièces sont garantis comme décrit ci-dessus; sinon, le service technique facturera la réparation au propriétaire du produit.

Remplir le formulaire de garantie

Date d'achat du produit:	Modèle N°:
Date d'expiration de la garantie:	N° de série:
<b>Tampon du distributeur</b>	
	





Pour le distributeur

## Formulaire de garantie

Date d'achat du produit:	Modèle N°:
Date d'expiration de la garantie:	N° de série:
Nom:	
Nom de la société:	
Adresse:	
Tel. :	Fax.:
E-mail:	
<b>Type d'activité:</b>	
<input type="checkbox"/> Agricole	<input type="checkbox"/> Carrosserie
<input type="checkbox"/> Réparations automobile	<input type="checkbox"/> Travaux publics
<input type="checkbox"/> Pneumatiques	<input type="checkbox"/> Industrie
<input type="checkbox"/> Maintenances et réparations poids lourd	<input type="checkbox"/> Particulier
<input type="checkbox"/> Fabricant automobile	<input type="checkbox"/> Autre _____
<b>Compresseur utilisé:</b>	
<b>Puissance CV:</b>	
<input type="checkbox"/> 5	<input type="checkbox"/> 7,5
<input type="checkbox"/> 10	<input type="checkbox"/> 15+
<input type="checkbox"/> Autre _____	
<b>Taille de la cuve (Litre):</b>	
<input type="checkbox"/> 75,7	<input type="checkbox"/> 227,1
<input type="checkbox"/> 302,8	<input type="checkbox"/> 454,2
<input type="checkbox"/> Autre _____	

# Garantiekarte

## Herstellergarantie

**Mighty Seven International CO., LTD.** bietet Kunden die Garantie mit gewisser Beschränkung für alle Produkte, die aus eigener Herstellung stammen und von **Mighty Sevens** weltweit autorisierten Fachhändlern gekauft worden sind. Garantieansprüche können nur gewährt werden, wenn der Mangel oder Schaden nachweislich auf unsachgemäße Herstellung oder die Verwendung fehlerhafter Materialien zurückzuführen ist. **Mighty Seven** haftet nicht für Beanstandungen der Werkzeuge, die auf unsachgemäße Handhabung, sowie zu hohen Betriebsdruck, oder der Verwendung von falschen Zubehörteilen zurückzuführen sind. **Mighty Seven** schuldet auch nicht für Ausfälle, die die mangelhafte Wartung und Überbeanspruchung der Werkzeuge nachweisen.

Garantieansprüche können nur dem Hersteller oder den autorisierten Fachhändlern gegenüber schriftlich geltend gemacht werden. Im Fall einer Reklamation sollen die defekten Teile mit der Kontaktanschrift des Absenders zurück an die Verkaufsstelle gesendet werden. Für die Werkzeuge, an denen eigenhändige Reparaturversuche bereits vorgenommen wurde, entfällt jeglicher Garantieanspruch.

Bitte diese Garantiekarte aufbewahren!

Einkaufsdatum:	Model-Nr.:
Garantieablaufdatum:	Serien-Nr.:
<b>Ihre Mighty Seven Fachhändler</b>	
	



Für Großhändler

## Garantiekarte

Einkaufsdatum:	Model-Nr.:
Garantieablaufdatum:	Serien-Nr.:
Name:	
Firmenname:	
Adresse:	
Tel.:	Fax.:
Email:	
<b>Branche:</b>	
<input type="checkbox"/> Agrarindustrie:	<input type="checkbox"/> Auto-Karosserie und Lackierer
<input type="checkbox"/> Allg. KFZ-Reparaturdienst	<input type="checkbox"/> für Öffentlichkeitsarbeit
<input type="checkbox"/> Reifenservice	<input type="checkbox"/> Produktion
<input type="checkbox"/> Nutzfahrzeug-LKW-Service	<input type="checkbox"/> Heimwerk
<input type="checkbox"/> Autohersteller	<input type="checkbox"/> Sonstiges _____
<b>Spezifikation des verwendeten Kompressors:</b>	
<b>Psi (bar):</b>	<b>Luftbehälter (Liter):</b>
<input type="checkbox"/> 5 <input type="checkbox"/> 7,5 <input type="checkbox"/> 10 <input type="checkbox"/> 15+	<input type="checkbox"/> 75,7 <input type="checkbox"/> 227,1 <input type="checkbox"/> 302,8 <input type="checkbox"/> 454,2
<input type="checkbox"/> Sonstiges _____	<input type="checkbox"/> Sonstiges _____

# Tarjeta de Garantía

## Garantía Limitada del Fabricante

**Mighty Seven International CO., LTD.** ofrece una garantía limitada a los productos fabricados por **Mighty Seven** y vendidos por sus agentes autorizados a nivel internacional. La garantía limitada sólo aplica a defectos de material o manufactura y no aplica a productos que hayan sido abusados, malusados, modificados o reparados por terceros ajenos a **Mighty Seven** o sus representantes de servicio autorizados. Si hubiera un defecto en un producto de Mighty Seven, por favor enviarlo prepagado al lugar donde fue comprado adjuntando su dirección e información de contacto. Las reparaciones o reemplazos son garantizados en los casos arriba explicados; de lo contrario las reparaciones o reemplazos tendrán un costo que deberá ser pagado por el cliente.

Por favor conservar esta tarjeta para Garantía

Fecha de Compra :	Modelo No. :
Fecha de fin de Garantía :	No. de Serie :

## Sello del Distribuidor





Para Distribuidor

## Tarjeta de Garantía

Fecha de Compra :	Modelo No. :
Fecha de fin de Garantía :	No. de Serie :
Nombre :	
Nombre de la Empresa :	
Dirección :	
Tel.:	Fax.:
Email:	
<b>Tipo de Negocio :</b>	
<input type="checkbox"/> Agricultura	<input type="checkbox"/> Pintura y reparación carrocería
<input type="checkbox"/> Reparación Gral. Autos	<input type="checkbox"/> Trabajo público / Gobierno
<input type="checkbox"/> Llantas	<input type="checkbox"/> Fábrica
<input type="checkbox"/> Reparación/mant.camiones	<input type="checkbox"/> Uso Casero
<input type="checkbox"/> Fabricante de Autos	<input type="checkbox"/> Otros _____
<b>Especificaciones de la compresora usada:</b>	
<b>Potencia (HP) :</b>	<b>Tamaño de tanque (litro) :</b>
<input type="checkbox"/> 5 <input type="checkbox"/> 7,5 <input type="checkbox"/> 10 <input type="checkbox"/> 15+	<input type="checkbox"/> 75,7 <input type="checkbox"/> 227,1 <input type="checkbox"/> 302,8 <input type="checkbox"/> 454,2
<input type="checkbox"/> Otros _____	<input type="checkbox"/> Otros _____

# Cartão de garantia

## Garantia limitada de fabricante

A **Mighty Mighty Seven International CO., LTD** oferece garantia limitada aos produtos por ela fabricados e vendidos globalmente por seus distribuidores autorizados. A garantia limitada aplica-se somente aos produtos que apresentarem defeitos de material ou manufatura, não cobrindo, portanto, produtos que forem usados incorretamente, danificados, modificados ou reparados por outros que não a própria **Mighty Seven International** ou seus distribuidores autorizados. Se houver um produto **Mighty Seven** defeituoso, por favor, envie-o com frete pago para o distribuidor onde ele foi comprado, incluindo no pacote informações para contato e endereço para devolução. Reparos ou trocas em garantia serão oferecidos conforme condições acima descritas. Nos demais casos peças e mão-de-obra serão cobrados.

Por favor, guarde este cartão para fins de garantia.

Data da compra:	Modelo:
Garantia válida até:	Nº de série:
<b>Carimbo do distribuidor</b>	
	



Distribuidor

## Cartão de garantia

Data da compra:	Modelo:
Garantia válida até:	Nº de série:
Nome:	
Nome da empresa:	
Endereço:	
Tel. :	Fax.:
E-mail:	
<b>Ramo de negócio:</b>	
<input type="checkbox"/> Agricultura	<input type="checkbox"/> Funilaria e pintura
<input type="checkbox"/> Reparação automotiva	<input type="checkbox"/> Órgão público
<input type="checkbox"/> Troca de pneus	<input type="checkbox"/> Indústria
<input type="checkbox"/> Reparação diesel	<input type="checkbox"/> Uso doméstico
<input type="checkbox"/> Montadoras	<input type="checkbox"/> Outras _____
<b>Especificações do compressor usado:</b>	
<b>Potência (hp):</b>	
<input type="checkbox"/> 5	<input type="checkbox"/> 7,5
<input type="checkbox"/> 10	<input type="checkbox"/> 15+
<input type="checkbox"/> Outras _____	
<b>Volume do Reservatório (litros):</b>	
<input type="checkbox"/> 75,7	<input type="checkbox"/> 227,1
<input type="checkbox"/> 302,8	<input type="checkbox"/> 454,2
<input type="checkbox"/> Outras _____	

# Гарантийный талон

## Компания-производитель

«*Mighty Seven International CO., LTD.*» предоставляет ограниченную гарантию на свою продукцию «*Mighty Seven*» сроком 12 месяцев с даты ее продажи потребителю через своих дистрибьюторов по всему миру.

Гарантия предполагает бесплатный ремонт или, в случае невозможности ремонта, замену неисправного инструмента «*Mighty Seven*» в соответствии с настоящими условиями:

1. Предоставление правильно заполненного данного Гарантийного Талона.
2. Ремонт или замена производится компанией-продавцом после технической экспертизы продукции. Экспертиза и ремонт производятся в разумные сроки уполномоченными представителями компании.
3. При невозможности замены или ремонта компания-продавец оставляет за собой право возместить стоимость продукции, попадающей под действие настоящих условий, при наличии документа, подтверждающего ее приобретение.

Гарантия не распространяется на инструмент, имеющий следующие признаки:

1. выработка, естественный износ,
2. несанкционированные конструктивные изменения,
3. отсутствие торговой марки «M7» или «Mighty Seven»
4. механические или технические повреждения, вызванные использованием не по назначению или с нарушением правил и норм эксплуатации и хранения.

В случае, если инструмент подлежит гарантии, производится бесплатный ремонт, а в случае его невозможности - бесплатная замена.

В случае, если инструмент не подлежит гарантии, может быть осуществлен ремонт на средства потребителя.

Компания-продавец не дает никаких гарантий, за исключением указанных выше. Все споры и разногласия, возникающие между покупателем и компанией-продавцом, должны решаться в рамках законодательства РФ.

Пожалуйста, сохраняйте гарантийный талон и товарный/кассовый чек в течение всего периода пользования инструментом.

Дата покупки:	Модель №:
Дата истечения гарантии:	Серийный №:
<b>Дистрибьютор</b>	
	





## Для дистрибьютора

Пожалуйста, сохраняйте гарантийный талон и товарный/кассовый чек в течение всего периода пользования инструментом.

Дата покупки:	Модель №:
Дата истечения гарантии:	Серийный №:
ФИО покупателя:	
Название компании:	
Адрес:	
Тел:	Факс:
e-mail:	
<b>Сфера деятельности:</b>	
<input type="checkbox"/> Сельское хозяйство	<input type="checkbox"/> Авто покраска и кузовной ремонт
<input type="checkbox"/> Авторемонтное предприятие	<input type="checkbox"/> Автосервис
<input type="checkbox"/> Шиномонтаж	<input type="checkbox"/> Производство автомобилей
<input type="checkbox"/> Ремонт грузового транспорта	<input type="checkbox"/> Частное пользование
<input type="checkbox"/> Торговля автомобилями	<input type="checkbox"/> Другое _____
<b>Мощность компрессора, необходимого для данного оборудования:</b>	
<b>кВт (лошадиные силы):</b>	<b>Объем компрессора: литров (галлонов):</b>
<input type="checkbox"/> 5 <input type="checkbox"/> 7,5 <input type="checkbox"/> 10 <input type="checkbox"/> 15+	<input type="checkbox"/> 75,7 <input type="checkbox"/> 227,1 <input type="checkbox"/> 302,8 <input type="checkbox"/> 454,2
<input type="checkbox"/> другое _____	<input type="checkbox"/> другое _____

## 保固卡

镁迪企业股份有限公司提供有限的产品保固, 范围仅限定由镁迪公司所生产制造, 并透过其全球各大合格经销商推广销售, 若因材质因素或制程瑕疵而导致缺陷之产品。反之, 若因不当使用、误用、自行拆卸、修改, 或非经由镁迪所授权之服务人员维修, 而造成产品故障或损伤, 则不在保固范围之列。

如果发现镁迪公司产品在保固范围内有上述缺陷, 请将产品连同地址、联络信息、购买发票及运费等, 送回原购买的经销商处进行维修。保固范围以外的所有维修或零件更换等需求, 经销商或服务据点得依实际维修内容收取相关费用。

请妥善保存此保固卡。

购买日:	产品型号:
保固有效期:	产品序号:
经销商章	
	



## 保固卡

销售日:	产品型号:
保固有效期:	产品序号:
姓名:	
公司名称:	
地址:	
电话:	传真:
电邮:	
通路别: <input type="checkbox"/> 农业机械 <input type="checkbox"/> 一般汽车维修 <input type="checkbox"/> 轮胎 <input type="checkbox"/> 卡车维修 <input type="checkbox"/> 汽车制造 <input type="checkbox"/> 车体烤漆&维修 <input type="checkbox"/> 公共工程/ 政府公共事业 <input type="checkbox"/> 工厂 <input type="checkbox"/> 居家修缮 <input type="checkbox"/> 其它 _____	
所使用的空压机规格: 马力 <input type="checkbox"/> 5 <input type="checkbox"/> 7.5 <input type="checkbox"/> 10 <input type="checkbox"/> 15+ <input type="checkbox"/> 其它 _____	
贮气槽 (gal): <input type="checkbox"/> 20 <input type="checkbox"/> 60 <input type="checkbox"/> 80 <input type="checkbox"/> 120 <input type="checkbox"/> 其它 _____	

