



Read this manual carefully before installing, operating, servicing or repairing.

Working environment:

1. Using these tools in any potentially explosive environment is strictly prohibited.
2. It is always recommended that these types of tools must be operated when standing on a solid or firm location.
3. Always use these tools in a well ventilated area.
4. Slipping, stumbling and falling are the major causes of potential serious injury, therefore, a clean and clutter free surface in the working area before operating the tools is strongly recommended.

Air supply and connection requirements:

1. The maximum recommended air pressure during operation must not exceed 90 psi (6.3bar). Higher air pressure may create unsafe operating conditions for the tool and the user.
2. The compressed air should be cooled and have a water filter installed at the outlet end of the compressor. Even with a water filter installed, some water may still condense in the piping or hose and will enter the tool mechanism causing premature damage to the tool. Therefore, it is recommended to install an air filter-lubricator device somewhere between the tool and the compressor.
3. Always use an air compressor of the proper capacity to operate each tool.
4. Clean the hose with a blast of compressed air before connecting the hose to the air tool. This will prevent both moisture and dust inside the hose from entering the tool and causing possible rust or malfunction.



Ideal system connection:

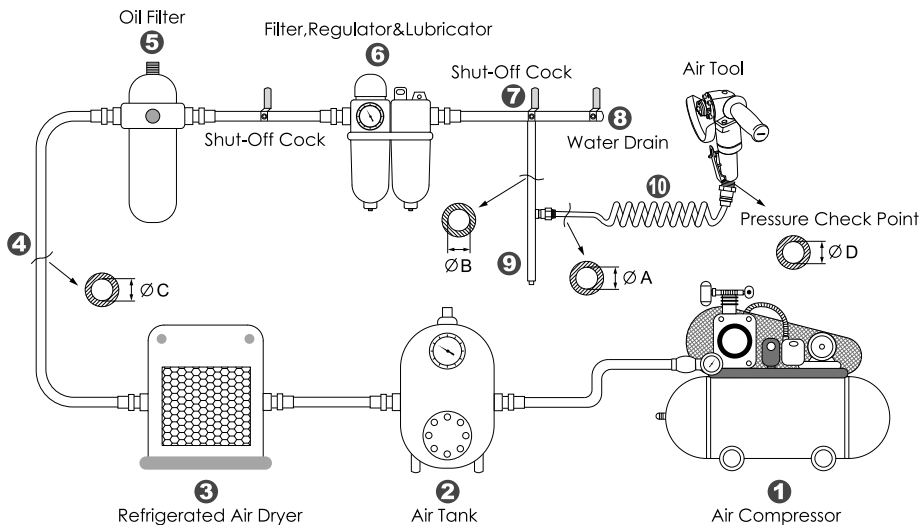

Piping diameters and length requirement:

- ★The diameter ΦA required for the inlet pipe (10) is recommended on the specification table.
- ★The diameter ΦB required for the branch pipe (from 7 to 9) should be 2 times as large as ΦA .
 $\Phi B = 2 \times \Phi A$
- ★The diameter ΦC required for the primary air supply (from 1 to 8) should be 3 times as large as ΦA .
 $\Phi C = 3 \times \Phi A$
- ★The length for the inlet pipe (10) should be less than 15 feet (4.5m).



Warning:

1. This tool should only be used as a hand operated tool. It is powered by compressed air and is not insulated against electric shock.
2. This tool is specially designed for grinding sharp edges, burrs, or a surface which needs to be cleaned or smoothed. Any application or use of this tool other than what it is designed for is strictly prohibited.
3. Make sure that the wheel dimensions are compatible with the grinder and the wheel fits the spindle.
4. High sound levels may cause hearing damage. Always wear hearing protection when operating this tool.
5. Wearing eye/face protection can reduce the danger of high-speed materials being emitted from the tool.
6. User must wear proper clothing. Loose clothing, long hair, stings, straps, belts and jewelry should not be worn when operating this tool.
7. Always wear gloves to reduce the risk of cuts or burns.
8. Working with certain materials may create emission of dust and fumes, which may cause a potential explosive environment and a hazard to the health. Therefore, wearing correct breathing protection and taking some preventive measures are recommended.
9. Make sure that the allowed operating speed of the grinding wheel to be used on this tool is higher than 15000R.P.M.
10. Inspect the grinding wheel carefully before use. Using a chipped, cracked or otherwise defective wheel will create an unsafe operating environment.
11. Make sure that the grinding wheel is correctly mounted and tightened before use. Run the tool at no-load for 30 seconds in a safe location to check the function. Stop immediately if there is considerable vibration or any other defects.
12. Also make certain that the wheel guard is in place, in good condition, is mounted correctly and is inspected regularly.
13. Ensure that the work piece is properly supported or fixed before operating.
14. Ensure there are no bystanders in the vicinity of working area.
15. Test run the tool to make sure of the rotation direction before practical use. This can reduce the potential hazard due to unexpected rotating direction.
16. Make sure that the direction of the sparks generated from the grinding wheel is properly directed so as to not create a hazard.
17. Always turn off the air supply and disconnect the air hose before replacing grinding wheel or making adjustments on this tool.
18. Make sure there is no gas or combustible material stored near the tool when servicing, changing insert tools, or storage.
19. It is forbidden to use a separate reduction bushing or adaptors to adapt lager hole grinding wheel.
20. To prevent an accidental start, rest the idle grinder in a stable position.
21. Release the throttle lever to avoid danger if there is a failure of energy supply and when connecting or disconnecting the air hose.
22. Examine the grinding wheel thoroughly before re-use if the tool has been dropped.
23. Prolonged use will cause user fatigue. Periodic breaks are recommended for user safety.
24. It is recommended to stop operating the tool whenever the user experiences discomfort, tingling or pain during use.
25. Beware if the compressed air hose breaks unexpectedly, or is being connected or disconnected improperly. This whipping action may cause injury.
26. The spindle speed needs to be checked regularly by a tachometer, with the grinding wheel removed. It should not be higher than the rated free speed under maximum operating pressure.
27. Avoid storing this tool where it is subject to high humidity.



Maintenance:

1. Before connecting the air hose to this tool or after operating, apply 4 or 5 drops of pneumatic oil into the air inlet and run it for several seconds, referring this operation to the attached picture.
2. Maintain this tool regularly by performing the same oiling application every 3 to 4 hours of operation.
3. Do not lubricate tools with flammable or volatile liquids. Use only the lubricant recommended by Mighty-Seven or authorized dealers. Any other lubricant will lead to reduce performance of the tool and permanent damage. Whenever any unauthorized lubricant is used by accident, flush it immediately with recommended pneumatic oil.
4. Follow all the recycling laws of waste disposal once this tool is no longer usable.

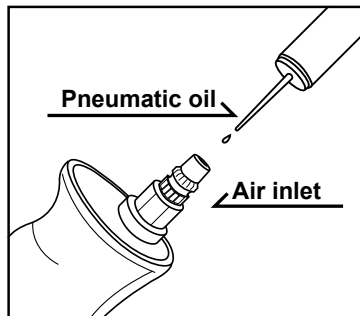

Regular maintenance

Grinding wheel replacing

Use the supplied spanners to replace.

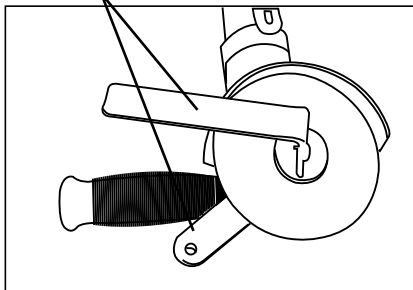

Regular lubricating:

Perform this lubricating with grease once a month.

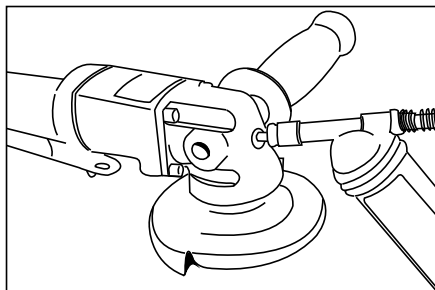



Lire ce guide avant toute installation, opération, maintenance ou réparation.

Environnement de travail:

1. L'outil ne doit pas être utilisé dans un lieu ayant une atmosphère potentiellement explosive.
2. Il est fortement conseillé d'utiliser ce genre d'outils avec une prise au sol ferme et solide.
3. Toujours utiliser l'outillage pneumatique dans un endroit bien ventilé.
4. Des installations encombrées et mal organisées sont une des principales causes de blessures en milieu de travail. Une aire de travail propre et libre de tout obstacle est requise pour assurer la sécurité au travail.

Pression et alimentation en air :

1. La pression d'air maximale recommandée ne devrait jamais excéder les 90 psi (6,3bar). Une utilisation à une pression d'air supérieur peut causer des dommages à l'outil et/ou pour son utilisateur.
2. L'air à la sorti du compresseur devrait être refroidi et passer à travers un filtre capteur d'humidité pour éviter les risques de condensation à l'intérieur de l'outil. L'humidité et la condensation peuvent créer de la rouille et une usure prématurée de l'outil. Pour cette raison, il est recommandé d'installer un filtre à air/lubrificateur quelque part entre l'outil pneumatique et le compresseur.
3. Utilisez un compresseur avec une capacité adaptée pour chaque outil.
4. Nettoyez le tuyau d'alimentation avec une décharge d'air avant chaque utilisation. Ceci évitera que de l'humidité et/ou des impuretés ne pénètrent à l'intérieur de l'outil et ne crée des problèmes de fonctionnement ou une usure prématurée.



Attention:



1. Tout l'outillage pneumatique devrait être opéré de façon manuelle. Ils sont alimentés par de l'air comprimé et ne sont pas conçus pour être utilisés dans des milieux sous tension électrique.
2. Cet outil est conçu spécifiquement pour meuler les surfaces, rebords ou coins tranchants, adoucir ou polir les pièces métalliques, de pierres ou de ciment. Toute autre utilisation de cet outil est fortement déconseillée.
3. S'assurer avant l'utilisation que les disques de meuleuse sont compatibles avec l'outil ainsi qu'avec l'axe d'attache.
4. Le niveau sonore élevé de l'outillage pneumatique peut causer des dommages auditifs permanents. Toujours porter une protection auditive lors de l'utilisation.
5. Il est fortement conseillé de se munir de protection pour les yeux et le visage afin d'éviter les blessures causées par débris ou de pièces éjectées à grande vitesse lors de l'utilisation de l'outil.
6. L'utilisateur se doit de porter des vêtements adéquats. Des vêtements amples, des cheveux longs, des attaches, sangles, ceintures ou bijoux ne devraient pas être portés lors de l'utilisation de ces outils.
7. Toujours porter des gants pour réduire les risques de coupures ou de brûlure
8. Le travail de certains matériaux peut créer de la poussière ou de la fumée. Afin de réduire les risques d'inhalation de poussière ou de débris lors du travail, le port d'une protection respiratoire est recommandé.
9. Vérifier de la vitesse orbitale du disque de meulage utilisé sur cet outil est supérieur à 15 000 RPM.
10. Vérifiez l'état et la condition des disques de meulage avant chaque utilisation. L'utilisation de disque craqué, fendus ou hors d'état d'utilisation peut être dangereux.
11. S'assurer que le disque de meulage soit solidement fixé à l'outil avant utilisation. Tester à vide dans un endroit sécuritaire l'outil pour une durée de 30 secondes pour s'assurer de son bon fonctionnement et du sens de rotation. Arrêter immédiatement l'outil s'il y a des vibrations anormales ou un mauvais fonctionnement de l'outil.
12. S'assurer que la garde de sécurité et de protection soit solidement fixée ainsi qu'elle est en bon état pour qu'elle puisse faire correctement son travail.
13. Vérifiez que la pièce à travailler est solidement fixée avant l'opération de l'outil.
14. S'assurez qu'il n'y aucun individu dans le périmètre immédiat de l'utilisateur.
15. Testez rapidement à vide l'outil avant chaque utilisation pour s'assurer de son sens de rotation. Ceci pourrait éviter des blessures dues à un sens de rotation inattendu.
16. S'assurer que les étincelles créées par le disque de meulage soient dirigées dans le sens opposé de l'utilisateur et dans une direction qui ne crée aucun risque pour son environnement.
17. Toujours éteindre l'alimentation en air et débrancher les raccords lors d'un changement de disque ou durant l'ajustement de l'outil.
18. S'assurer que l'environnement de travail soit exempt de tout gaz ou matériel combustible avant de ranger ou de faire l'entretien de l'outil.
19. Il ne faut jamais utiliser d'adaptateur pour installer un disque de meulage non ajusté pour l'outil.
20. Afin de prévenir les mises en marche accidentelle, positionner l'outil hors fonction dans une position stable.
21. Relâchez la gâchette lorsqu'il y a un problème d'alimentation ou lors du débranchement de l'outil.
22. Vérifiez l'état du disque de meulage minutieusement avant sa réutilisation si l'outil à été échappé.
23. Des périodes d'utilisation prolongée peuvent causer de la fatigue. Des pauses régulières sont conseillées pour augmenter la sécurité de l'utilisateur.
24. Il est recommandé d'arrêter immédiatement le travail lorsqu'un malaise ou une forte fatigue est ressenti lors de l'utilisation prolongée de cet outil.
25. Toujours faire attention à un éventuel bris du tuyau d'alimentation en air et lors de son débranchement intentionnel ou accidentel. Le fouettement du tuyau d'alimentation peut causer des blessures.
26. La vitesse de rotation de l'axe doit être contrôlée régulièrement par un tachymètre, le disque de meulage enlevé. La vitesse observée en RPM ne devrait pas dépasser la vitesse à vide maximale mentionnée dans le guide d'utilisation.
27. Évitez de ranger cet outil dans un endroit ou l'air est humide.



Maintenance:

1. Avant l'utilisation ou avant de brancher le tuyau d'alimentation, déposer 4 ou 5 gouttes d'huile pneumatique par l'admission d'air et faire fonctionner l'outil pendant quelques secondes.
2. Procédez à une lubrification régulière de l'outil à toutes les 3 ou 4 heures d'utilisation.
3. Ne pas lubrifier l'outil avec des produits volatiles ou inflammables. Seule l'utilisation de lubrifiants recommandés par M7 ou un revendeur autorisé est permise. Tout autre lubrifiant peut réduire la durée de vie de l'outil. Purger avec de l'huile pneumatique tout outil ayant reçu accidentellement tout autre type de lubrifiant.
4. Si l'outil est trop endommagé pour être encore utilisé, déposez-le dans une déchetterie pour qu'il soit recyclé.

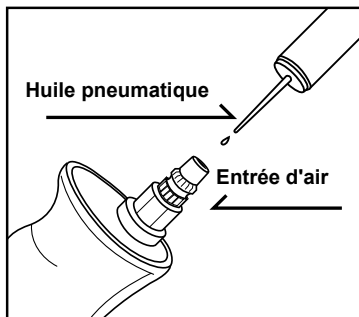

Entretien régulier

Remplacement du disque

Utilisez la clé ci-jointe pour le remplacement.

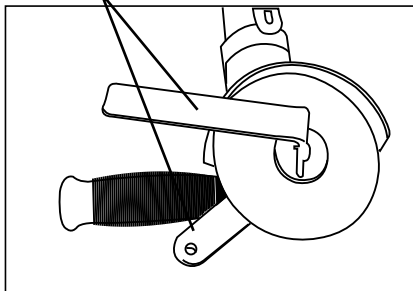

Lubrification normale:

Lubrifiez l'outil avec de la graisse une fois par mois.

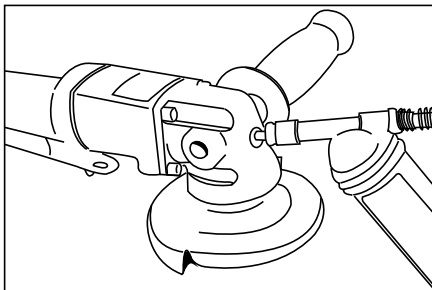



Bitte lesen Sie die beigelegte Anweisung sorgfältig vor der Installation, der Arbeit, Wartung und dem Wechsel des Zubehörs mit der Fettpresse.

Sicherheitshinweise:

1. Es ist strikt verboten, die Druckluftschlagschrauber in einem explosionsgefährdeten Arbeitsumfeld zu benutzen.
2. Es ist ratsam, das Werkzeug auf einer festen Arbeitsfläche zu verwenden, z. B. auf einem festen und ebenen Arbeitsplatz.
3. Beachten Sie, dass die Arbeitsumgebung mit dem Druckluftwerkzeug immer gut belüftet sein soll.
4. Vor der Benutzung eines Druckluftwerkzeugs sichern Sie eine saubere, geräumige und feste Arbeitsumgebung ab, da Rutschen, Anstoßen und Zubruchgehen die Hauptgründe für Schadensentstehung sind.

Luftversorgungssystem:

1. Der in der Bedienungsanleitung angegebene maximale Arbeitsluftdruck, 90 psi bzw. 6,3 bar, für das Druckluftwerkzeug ist NICHT zu überschreiten, da dies zu Verletzungen und erhöhtem Materialverschleiß führen kann.
2. Die Druckluftzufuhr soll durch den in der Anlage eingebauten Lufttrockner abgekühlt werden und am Druckluftabgang durch den installierten Filter gefiltert werden. Trotzdem könnte, je nach den Umgebungsverhältnissen, immer wieder Kondenswasser in der Leitung entstehen. Die Feuchtigkeit verursacht bekanntlich Schäden und Leistungsverlust für das Werkzeug. Daher empfehlen wir unseren Kunden, eine Wartungseinheit wie den „Filter, Regler & Öler“ an einer Stelle zwischen der Luftzufuhr und dem Werkzeug zu installieren. Diese zusätzliche Wartungseinheit gewährleistet ein ideales Luftversorgungssystem für die Arbeit mit dem Werkzeug und verhindert gleichzeitig die Korrosionsbildung.
3. Bitte verwenden Sie immer einen Kompressor, der die passende Luftkapazität für das Gerät hat.
4. Vor dem Anschluss eines Druckluftwerkzeugs reinigen Sie mit Gebläseluft den Luftschlauch. Dies verhindert, dass die in dem Luftschlauch existierende Feuchtigkeit und Staub ins Werkzeug eindringen und schützt so vor Korrosionsbildung und Verschleiß des Werkzeugs.



Allgemeine Sicherheitshinweise:



1. Dieses Werkzeug kann nur für manuelle Arbeit eingesetzt werden und wird angetrieben mittels der durch einen Kompressor bereitgestellten Druckluft. Dieses Werkzeug ist nicht isoliert gegen Elektroschock.
2. Dieses Werkzeug ist speziell ausgelegt für die Anwendung zum Schleifen, zum Schruppen oder zum Polieren der Spannfläche. Jede andere Verwendung ist strikt verboten.
3. Stellen Sie sicher, dass die Tellergröße auf den Schleifer und den Spindel passt.
4. Bei hohen Geräuschpegeln ab 85 dB(A) ist am Arbeitsplatz ein Gehörschutz zu tragen.
5. Ein bruchstärkerer Augenschutz ist stets zu tragen, um sich vor absplitternden Teilen zu schützen.
6. Immer Arbeitsschutzkleidung tragen! Bei der Arbeit sollen eng anliegende Kleidungsstücke getragen werden. Es sollen kein Gürtel, kein Schmuck und keine langen Haare getragen werden.
7. Immer Arbeitshandschuhe tragen, um sich vor Arbeitsgefahren, wie Verbrennungen oder Schnitten zu schützen!
8. Bei Arbeit mit jedem Material, das Staub oder Rauch verursacht, ist es ratsam, Atemschutz zu tragen.
9. Stellen Sie sicher, dass die zulässige Arbeitsgeschwindigkeit des Schleifrads im Einsatz höher als 15000Rpm ist.
10. Immer vor der Verwendung das Schleifrad genau prüfen, falscher Einsatz kann zur unsicheren Arbeitsbedingungen führen.
11. Stellen Sie sicher, dass das Schleifrad richtig montiert und vor der Verwendung angezogen ist. Dann starten Sie das Testprogramm im Leerlauf für 30 Sekunden an einem sicheren Ort, um die Funktion und die Drehrichtung des Werkzeugs zu überprüfen. Stellen Sie die Arbeit sofort ein, wenn erhebliche Vibrationen oder sonstige Defekte in Erscheinung treten.
12. Stellen Sie sicher, dass der Radschutz vorhanden, in gutem Zustand und korrekt eingesetzt ist. Prüfen Sie dies regelmäßig.
13. Stellen Sie sicher, dass das Werkstück vor der Inbetriebnahme richtig fixiert ist.
14. Stellen Sie sicher, dass sich keine unbefugte Person in der Nähe der Arbeitsfläche befindet.
15. Bitte einen Testlauf des Werkzeugs starten, um die Drehrichtung des Werkzeugs vor dem praktischen Einsatz zu bestätigen. Dadurch verringert sich die potentielle Gefahr aufgrund unerwarteten Drehrichtungswechsels.
16. Bei der Arbeit beachten Sie, dass die entstehenden Funken Gefahren darstellen, und zu Verletzungen führen könnten.
17. Vor einem Zubehörwechsel oder vor einer Einstellung ist das Werkzeug grundsätzlich von der Luftleitung abzukuppeln und diese von Druck zu entlasten.
18. Stellen Sie sicher, dass kein Gas oder brennbare Materialien in der Nähe von dem Werkzeug gelagert sind während der Servicearbeit, dem Zubehörwechsel oder beim Lagern des Werkzeugs.
19. Es ist strikt verboten, eine separate Reduktionsbuchse zur Anpassung der Größe des Schleifteller-Lagerlochs zu verwenden.
20. Gegen unbeabsichtigtes Einschalten des Bohrers stellen Sie das Werkzeug im Leerlauf immer auf einer stabilen Arbeitsfläche ab.
21. Den Druckauslöser des Werkzeugs im Fall eines Motorschadens oder einer Unterbrechung der Luftschlauchverbindung sofort loslassen
22. Prüfen Sie das Schleifrad gründlich, bevor Sie das Werkzeug wieder verwenden, wenn das Werkzeug davor fallen gelassen wurde.
23. Nach lang andauernder Benutzung können extreme Schwingungen Taubheitsgefühle für die Hände hervorrufen. Zu Ihrem eigenen Gesundheitsschutz ist es ratsam, öfters eine Pause bei der Arbeit einzulegen.
24. Die Arbeit mit dem Werkzeug ist sofort einzustellen, wenn sich der Benutzer während der Arbeit unwohl fühlt oder ein Kribbeln empfindet.
25. Achten Sie besonders darauf, dass die Luftzufuhr beim Luftschlauch nicht unerwartet unterbrochen wird bzw. die Luftversorgung ruckartig austritt. Dies kann zu Schäden führen
26. Die Spindeldrehzahl muss in regelmäßigem Abstand anhand eines Drehzahlmessers kontrolliert werden, vor allem nach dem Spindelwechsel. Die Drehzahl sollte NICHT höher als die Bemessungsdrehzahl im Freilauf bei maximalem Betriebsdruck sein.
27. Lagern Sie das Werkzeug niemals in einer feuchten Umgebung.

Wartungshinweise

1. Nach dem Gebrauch oder vor dem Anschluss ist es ratsam, mit etwas Öl den Drucklufteingang zu schmieren und danach ein paar Sekunden einen Testlauf zu starten.
2. Das Werkzeug soll regelmäßig - jeweils nach einer 3- oder 4-stündiger Benutzung - mit Schmieröl gewartet werden.
3. Bitte verwenden Sie auf keinen Fall entflammbares oder flüchtiges Öl zur Wartung des Werkzeugs. NUR das von dem Hersteller angegebene Schmieröl verwenden!
4. Nach der endgültigen Abnutzung des Werkzeugs befolgen Sie alle Umweltschutzrichtlinien für die Abfallentsorgung bzw. Abfallbeseitigung.

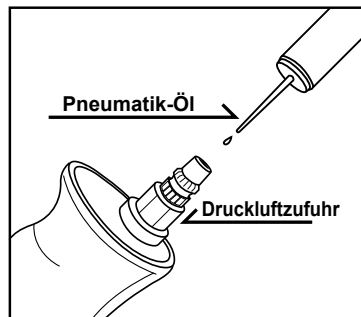

Reguläre Wartung

Schleifrad-Wechsel:

Bitte verwenden Sie den beigegefügt Schlüssel beim Wechseln des Schleifrads.

Achtung: Beim Öffnen und beim Wechseln des Schleifrads, Drehung gegen Uhrzeigerichtung.

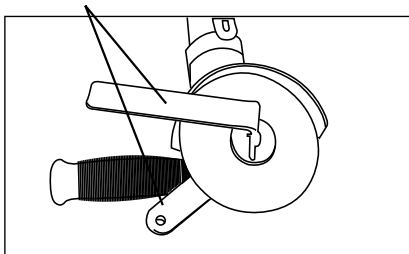

Reguläre Wartung:

Führen Sie eine reguläre Schmierung des Werkzeugs einmal im Monat durch!

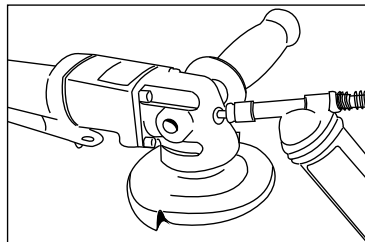



Lea este manual cuidadosamente antes de instalar, operar, realizar el servicio técnico o la reparación de la herramienta.

Ambiente de trabajo:

1. El uso de estas herramientas está prohibido en ambientes potencialmente explosivos.
2. Es siempre recomendado que este tipo de herramientas sean operadas parándose sobre un lugar sólido o firme.
3. Siempre usar estas herramientas en un lugar con buena ventilación.
4. Resbalarse, tropezarse y caerse son las mayores causas de daños potencialmente serios, por lo que se recomienda operar las herramientas en una superficie limpia y libre de abarrotamiento dentro del área de trabajo.

Requerimientos de surtido de aire y conexiones:

1. La presión máxima de operación no debe exceder de 90 psi (6.3bar). Una presión de aire mayor podría crear condiciones de operación no seguras para la herramienta y el usuario.
2. El aire comprimido debe ser enfriado y tener un filtro de agua instalado en el lado de salida del compresor. Aún con el filtro de agua instalado, algo de agua podría condensarse todavía en las tuberías o la manguera y entrar en el mecanismo de la herramienta, causando daños prematuros a la misma. Por ello es recomendable instalar un dispositivo filtro-lubricador de aire en algún punto de la línea entre la herramienta y el compresor.
3. Siempre usar el compresor de aire de la capacidad apropiada para operar cada herramienta.
4. Limpiar la manguera con un soplo de aire comprimido antes de conectar la manguera a la herramienta de aire. Esto evitará que la humedad y la suciedad dentro de la manguera ingresen a la herramienta causando su oxidación o malfuncionamiento.



Advertencia:



1. Esta herramienta debe ser usada únicamente como una herramienta operada manualmente. Funciona con compresora de aire y no está aislada contra choques eléctricos.
2. Esta herramienta está especialmente diseñada para esmerilar bordes filudos, y limpiar o alisar superficies de metal. Cualquier uso de esta herramienta ajeno al propósito para el que fue diseñada, está estrictamente prohibido.
3. Asegúrese que las dimensiones del disco de amolar sean compatibles con el modelo de la herramienta (5" ó 7") y que el disco encaje perfectamente en el eje de la herramienta.
4. Sonidos de niveles altos podrían causar daños al oído. Use siempre protección al operar esta herramienta.
5. El uso de protección de ojos y cara puede reducir el peligro causado por materiales que puedan ser expulsados a alta velocidad por la herramienta en uso.
6. El operario debe usar ropa apropiada. Ropa muy suelta, pelo largo, cordones, tirantes, correas y joyería no deben ser usados cuando se opere esta herramienta.
7. Siempre utilice guantes para reducir el riesgo de cortes o quemaduras.
8. Trabajar con ciertos materiales puede crear emisiones de polvo y gases, pudiendo causar un ambiente potencialmente explosivo y dañino para la salud. Asegúrese de utilizar mascarillas apropiadas para protección de la respiración y tomar medidas preventivas
9. Asegúrese que el disco de amolar utilizado sea apto para funcionar a una velocidad igual o superior a 15000 R.P.M.
10. Inspeccione el disco de amolar cuidadosamente antes de usarlo. Usar un disco astillado, rajado o defectuoso crearía un ambiente de operación no seguro.
11. Asegúrese que el disco de amolar sea correctamente instalado y ajustado antes de usar la herramienta. Luego, encienda la herramienta libre de carga por 30 segundos en un lugar seguro para revisar su funcionamiento. Deténgala inmediatamente si nota vibraciones o ruidos extraños.
12. Verifique siempre que el protector del disco esté en su sitio, en buena condición y montada correctamente.
13. Asegúrese de que la pieza a trabajar se encuentre sujeta o fija apropiadamente antes de operar.
14. Asegúrese que no haya personas ajenas a la labor cerca del área de trabajo.
15. Realice un encendido de prueba de la herramienta para asegurarse del sentido de rotación antes de ponerla en uso. Esto podría reducir el peligro potencial causado por una dirección de rotación inesperada.
16. Asegúrese que la dirección de las chispas generadas por el disco de amolar sean correctamente dirigidas para no ocasionar algún riesgo.
17. Siempre apague la fuente de suministro de aire y desconecte la manguera de aire antes de cambiar el disco de amolar o de realizar algún ajuste en la herramienta.
18. Asegúrese que no haya gas o material combustible almacenado cerca al realizar mantenimiento, cambio de piezas que deban ser insertadas o almacenamiento de la herramienta.
19. Está prohibido el uso de piezas adicionales o adaptadores para reducir o agrandar la abertura de la rueda de amolar.
20. Para prevenir un encendido accidental de la herramienta, coloque la herramienta en una posición estable cuando no esté siendo utilizada.
21. Suelte el gatillo de aceleración para evitar peligro si existe una falla en el suministro de energía eléctrica o cuando conecte o desconecte la manguera de aire.
22. Examine el disco de amolar con cuidado antes de volverla a utilizar en caso de que la herramienta se haya caído.
23. Largos periodos de uso prolongado causa fatiga del usuario. Descansos periódicos son recomendados para seguridad del usuario.
24. Se recomienda interrumpir el uso de la herramienta en caso de experimentar incomodidad, cosquilleo o dolor durante su uso.
25. Tenga cuidado si la manguera de aire se rompe inesperadamente, o si se conecta o desconecta de manera inapropiada. El efecto azote de tal acción podría causar lesiones.
26. Verifique regularmente la velocidad de rotación del eje de la amoladora utilizando un tacómetro. La velocidad de éste, sin la piedra de amolar, no debe ser mayor a la velocidad libre especificada para el modelo, a una presión máxima de 90 PSI (6.3 bar).
27. Evite almacenar esta herramienta en lugares muy húmedos.



Mantenimiento:

1. Antes de conectar la manguera de aire o luego de usarla, aplique 4 ó 5 gotas de aceite neumático en la entrada de aire y déjela encendida por varios segundos.

2. Realice un mantenimiento regular de esta herramienta repitiendo la misma operación lubricación cada 3 ó 4 horas de uso.

3. No utilice líquidos inflamables o volátiles para lubricar esta herramienta.

Utilice únicamente el lubricante recomendado por Mighty-Seven o agentes autorizados. Cualquier otro lubricante producirá una disminución

en el desempeño de la herramienta y daño permanente. Si se utiliza accidentalmente un lubricante no autorizado, quítelo inmediatamente vertiendo encima aceite neumático recomendado.

4. Respete todas las leyes de reciclaje y desechos una vez que esta herramienta sea desechada.

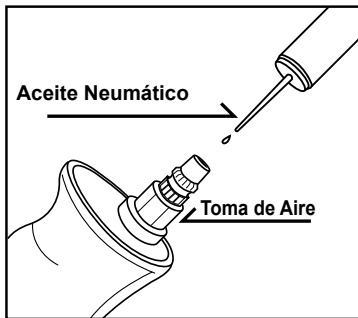

Mantenimiento regular

Reemplazo del disco de amolar

Use las llaves de tuercas adjuntas para realizar el reemplazo.

Note Nota: Girar en sentido anti-horario para abrir y reemplazar.

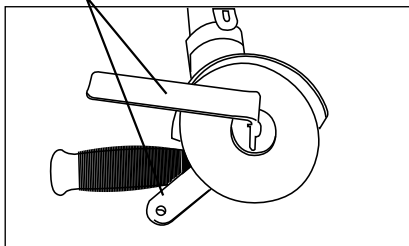

Lubricación Regular:

Realizar esta lubricación con grasa una vez al mes.

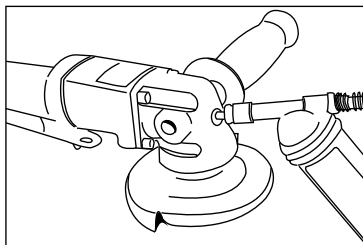



Leia atentamente este manual antes de instalar, operar, carregar ou reparar sua engraxadeira pneumática.

Recomendações sobre a área de trabalho:

1. Nunca trabalhe com esta ferramenta pneumática em ambientes potencialmente explosivos.
2. Deve oferecer uma base firme e sólida o piso sobre o qual o operador trabalhará com esta ferramenta pneumática.
3. Trabalhe com esta ferramenta somente em áreas bem ventiladas.
4. Tropeços, escorregões e quedas, enquanto estiver trabalhando com ferramentas pneumáticas, podem ser potencialmente perigosos. Procure manter a área de trabalho seca e livre de obstáculos.

Requisitos para a linha de ar e conexões:

1. A pressão máxima de trabalho não deve ultrapassar 90 psi (6,3 bar). Pressões mais altas podem danificar a ferramenta e machucar o operador.
2. O ar comprimido deve ser resfriado e filtrado na saída do compressor. Mesmo tomando estas medidas, um pouco de umidade pode se condensar dentro das tubulações e entrar na ferramenta pneumática, reduzindo sua vida útil. Por essa razão é recomendada a instalação de um conjunto de filtro e lubrificador de ar em algum ponto da linha entre a ferramenta e o compressor.
3. O compressor deve ter capacidade compatível com o consumo do número de ferramentas pneumáticas a ele conectadas.
4. Limpe o interior da mangueira com um jato de ar comprimido antes de conectá-la à ferramenta pneumática. Esse procedimento evita que sujeira e umidade sejam carregadas para dentro da ferramenta, danificando-a.



Atenção:

1. Esta é uma ferramenta de uso manual apenas. Ela é alimentada por ar comprimido e não possui isolamento elétrico algum.
2. Esta ferramenta foi projetada para esmerilhar cantos vivos e desbastar superfícies metálicas. É vedado seu uso para qualquer outra finalidade.
3. O diâmetro do disco de desbaste deve estar de acordo com o modelo da ferramenta (5" ou 7"). O disco de desbaste deve encaixar-se perfeitamente ao eixo da ferramenta.
4. A exposição a ruídos elevados pode provocar danos auditivos irreversíveis. Use sempre protetores auriculares ao trabalhar com esta ferramenta pneumática.
5. O uso de óculos e máscara de proteção reduz o risco de ferimentos decorrentes de pequenasagulhas oriundas do disco de corte.
6. O uniforme deve ser adequado ao trabalho com ferramentas de alta rotação. Tiras e pontas soltas de tecido, cintas, correntes de pesoço ou pulseiras, assim como cabelos compridos, podem se enroscar na ferramenta e provocar sérios acidentes.
7. Trabalhe sempre luvas para evitar cortes ou queimaduras.
8. Outros equipamentos de proteção ou dispositivos para coletar o pó produzido durante o corte podem ser necessários dependendo do tipo de material a ser cortado. Consulte manuais específicos.
9. Certifique-se que os discos de desbaste sejam próprios para rotações além de 15.000 RPM.
10. Inspeccione o disco de desbaste cuidadosamente antes de trabalhar com a ferramenta. Jamais trabalhe com discos de corte trincados ou danificados.
11. Certifique-se que o disco de corte esteja bem encaixado e preso. Faça a ferramenta trabalhar livre por alguns segundos e observe se não há vibrações ou outros problemas.
12. Trabalhe sempre com a capa protetora instalada, verificando periodicamente a fixação da mesma.
13. Certifique-se que a placa ou peça a ser desbastada encontra-se firmemente presa.
14. Evite que pessoas fiquem próximas desnecessariamente enquanto estiver trabalhando com essa ferramenta.
15. Preste atenção ao sentido de rotação da ferramenta para evitar acidentes.
16. Certifique-se de orientar as faíscas geradas pelo desbaste em direção a uma área livre de pessoas.
17. Sempre desconecte a mangueira de ar ao efetuar ajustes na ferramenta, bem como ao trocar discos de desbaste.
18. Observe se não há líquidos inflamáveis próximos à ferramenta ao efetuar a troca dos discos ou armazená-la.
19. Nunca use adaptadores para reduzir o diâmetro de discos de corte impróprios para essa ferramenta pneumática.
20. Apóie a ferramenta em posição adequada enquanto não estiver em uso de forma a evitar um funcionamento acidental.
21. Solte imediatamente o gatilho da ferramenta, se houver queda de energia ou se a mangueira de ar se desconectar.
22. Se a ferramenta cair, verifique atentamente se não há fissuras no disco de desbaste.
23. O trabalho ininterrupto por longos períodos pode causar fadiga. Recomenda-se efetuar pausas de vez em quando para evitar acidentes decorrentes da fadiga do operador.
24. Interrompa o trabalho imediatamente se sentir desconforto, dor ou mesmo formigamento dos membros ao usar esta ferramenta pneumática.
25. Esteja sempre atento a um possível chicoteamento da mangueira de ar, caso ela se rompa ou se desconecte acidentalmente da ferramenta.
26. Verifique periodicamente rotação do eixo da esmerilhadeira usando um tacômetro. A rotação deste eixo, sem nenhum disco de desbaste, não pode ultrapassar a rotação livre especificada para o modelo da esmerilhadeira sob a pressão de 90 PSI (6,3 bar).
27. Evite guardar a ferramenta pneumática em locais sujeitos a muita umidade.

Manutenção:

1. Antes de conectar a mangueira de ar à ferramenta, pingue 4 a 5 gotas de óleo no furo de entrada de ar. Conecte a mangueira, aperte o gatilho e deixe a ferramenta funcionando por alguns segundos para lubrificá-la internamente.
2. Lubrifique novamente a ferramenta a cada intervalo de 3 ou 4 horas trabalhadas.
3. Utilize apenas óleo máquina SAE 10-20 para lubrificar sua ferramenta pneumática. Se outro líquido foi introduzido acidentalmente na máquina, faça com que ele seja expelido, introduzindo um volume maior de óleo SAE 10-20.
4. Ao descartar essa ferramenta pneumática ou suas partes, verifique a possibilidade de encaminhá-la para centros de reciclagem, colaborando para a reduzir a quantidade de lixo no meio-ambiente.



Lubrificação periódica

Trocando o disco de desgaste:

Use as chaves fornecidas para troca o disco de desgaste.

Atenção: faça o movimento no sentido anti-horário para soltar o disco e efetuar a troca.

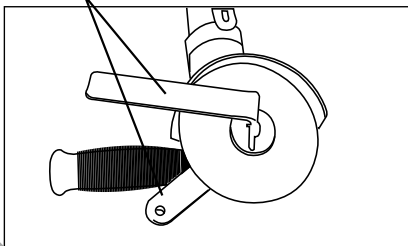

Lubrificação periódica:

Lubrifique a ferramenta com graxa uma vez por mês.

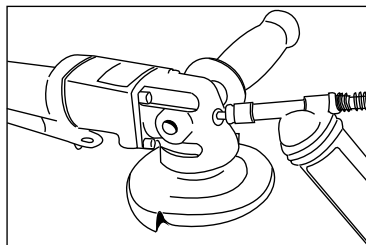



进行安装、操作、维修或更换零件之前，请务必详读本使用手册。

工作环境:

1. 严格禁止在任何具有爆炸性气体的环境中使用本气动工具。
 2. 当使用本气动工具时务必站立在坚实稳固的物体或位置上。
 3. 使用本气动工具的场所，其通风条件必须十分良好。
 4. 滑倒、绊倒和从高处跌落…等等状况乃操作气动工具时最容易发生的意外状况，因此在操作之前，务必先将工作场所清理干净。
-

风源及安装需求:

1. 操作本气动工具的最大空气压力值不得超过90psi。高于此压力值时将可能对本气动工具或使用者带来危险。
2. 用于本气动工具的压缩空气必须经过冷却处理，在空压机出口端务必加装一只过滤器，以便过滤压缩空气中的水分。即便如此，仍会有少部分的水气凝结于空压管路当中，甚至渗进本气动工具的机械结构内部，造成本气动工具难以预期的损害。是故，压缩空气的管路在进入本气动工具之前的某适当位上，应予加装一只三点组合。
3. 使用者应根据各种不同气动工具的需求，选择不同规格的空气压缩机。
4. 开始操作本气动工具之前，应先将管路中的水气排除干净。如此，当可避免残留在压缩空气中的水分或灰尘进入本气动工具内部，将影响到本气动工具的正常性能，甚至造成损坏。



⚠ 作业注意事项: ⚠

1. 本气动工具完全采用压缩空气来加以驱动, 仅限以手动方式进行操作。因本气动工具并不具备绝缘效果, 故, 使用时应特别注意不可接近电源。
2. 本气动工具是专为磨除锐角、毛边、突起或磨平特定平面…等等而设计的气动工具, 除前述用途之外, 其它各类的不当使用均必须严格禁止。
3. 使用本气动工具前请务必确认所用砂轮片的规格及内孔与本气动工具相吻合。
4. 高分贝的噪音可能会使听力受损。故, 当使用本气动工具时请务必戴上防护耳罩。
5. 为防范因异物或屑屑飞出而造成危险, 操作本气动工具时请务必穿戴眼部 / 脸部护具。
6. 使用者在使用本气动工具时, 应绝对避免穿着宽松的衣服或配戴过长的腰带、珠宝、首饰…等等物品; 长头发亦必须包扎妥当。
7. 操作本气动工具时请穿戴手套, 以避免遭到割伤或烫伤。
8. 本气动工具运用在某些特定材质时会喷射出粉尘和烟尘, 此现象将会使工作环境潜藏爆炸性, 并对人体健康造成危害。因此使用时务必配戴呼吸保护器具和适当的防护措施。
9. 选择砂轮片时, 请务必确认其最高转速必须超过15000R. P. M.
10. 使用前务必仔细地检查砂轮片状况。使用有缺口、破裂或其它具有瑕疵的磨石时, 将会产生安全上的疑虑。
11. 使用前务必确定砂轮片必须正确地锁紧在本气动工具上。并于安全的处所使本气动工具在无负载的情况下空转30秒, 以确定本气动工具的功能和方向。如遇异常震动或非预期状况则应立即停机。
12. 同时亦应确认砂轮护罩确实安装于本气动工具上, 且功能正常无虞。
13. 操作之前应再次确认工作物已被确实固定或夹持。
14. 使用前务必确定工作范围内没有其它不相关的旁观者。
15. 正式使用本气动工具之前应进行试转以确认工作轴运转方向。此动作可有效降低因错误回转所带来的潜在性危险。
16. 使用前务必确定砂轮片产生的火花方向不会产生任何的危险。
17. 在更换砂轮片或调整本气动工具时, 请务必关闭风源, 并将本气动工具与空压机软管脱离。
18. 更换, 拆卸, 维修, 储放及操作本气动工具的场所周遭, 绝对不得存放瓦斯或其它任何可燃性的气体。
19. 本气动工具严禁采用其它分离式衬套或“大转小”接头来使用较大孔径的砂轮片。
20. 为了避免非预期的启动, 停机不用时应将本气动工具放置于稳固的场所。
21. 当连接或脱离空压机软管, 或风源供应产生问题时, 均应立即释放扳机, 以免造成危险。
22. 若不小心将本气动工具掉落地面, 再次使用之前务必彻底检查砂轮片状况是否完好堪用。
23. 长时间使用本气动工具将会造成使用者疲劳, 为了使用者的安全着想, 请务必实施周期性地休息。
24. 在使用中有任何不适、颤抖、或疼痛的感觉时, 请务必立即停机休息。
25. 不当拆卸、连接空压机软管, 或非预期性的软管断裂都将造成空压机软管的任意甩动, 此类危险状况, 操作之时宜特别注意。
26. 本气动工具砂轮片心轴需定期将砂轮片移除, 并检查其回转速度。在最高工作风压的情况下, 其转速不得高于额定回转速度。
27. 应尽可能避免将本气动工具储放在高湿度的环境当中。



维护与保养：

1. 本气动工具于使用之前及使用完毕之后，均应从进气口处加入4或5c.c的气动油，并空转几秒以清洁各部件。
2. 每使用3至4个小时，请务必再次添加气动油，并空转几秒以进行保养。此项作业对于维护本气动工具的性能，及提升其使用寿命具有绝对的帮助。
3. 保养本气动工具时绝对禁止使用任何易燃性或具挥发性的液体。仅建议使用经本厂授权的服务中心所介绍的润滑油脂。任何其它的润滑油脂均有可能降低本气动工具的功能，甚至造成永久性的损坏。当不小心使用到其它润滑油脂时，则请立即用建议的润滑油脂将其清洗干净。
4. 如果本气动工具已然不堪使用，请务必遵照相关废弃物回收法令进行后续处置。

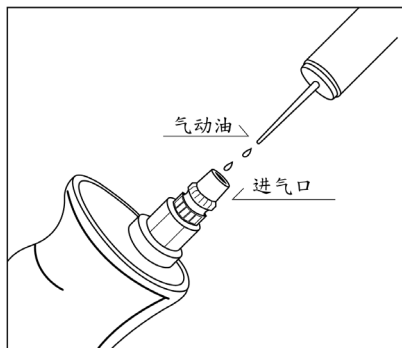

气动工具之日常润滑保养

更换砂轮片的方式：



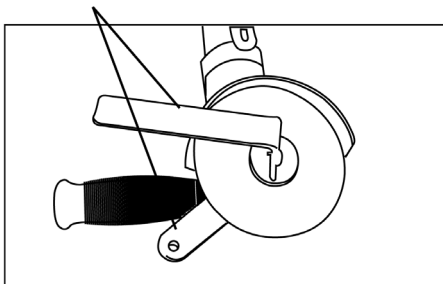



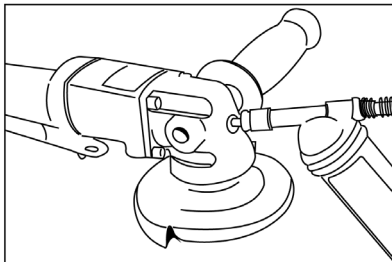

同时运用两支附件扳手进行更换。











转动机件润滑保养：

每月应以多功能润滑油脂进行保养。



Item No.	Pad Dia	Free Speed	Ave. Air Consumption	Air Pressure	Overall Length	Motor	Net Weight	Air Hose	Sound Pressure	Vibration level
	inch	R.P.M	CFM	PSI	inch	hp	LBS	inch	dBA	m/s ²
Illustrator						hp				
QB-104	4"	11000	6.0	90	8-7/8"	0.78	4.0	3/8"	87.8	1.2
QB-105	5"	11000	6.0	90	8-7/8"	0.78	4.0	3/8"	87.1	1.2
QB-114	4"	11000	6.0	90	9"	0.78	4.0	3/8"	87.8	1.2
QB-115	5"	11000	6.0	90	9"	0.78	4.0	3/8"	87.1	1.2
QB-185	5"	12000	6.0	90	9-9/64"	1.40	6.2	1/2"	86.0	2.1
QB-187	7"	7000	6.0	90	9-23/32"	2.00	8.8	1/2"	86.0	2.1
QB-194	4"	12000	4.9	90	8-15/32"	0.90	4.2	3/8"	91.0	2.6
QB-194L	4"	12000	4.9	90	10-23/32"	0.90	4.6	3/8"	89.0	2.5
QB-194CN	4"	13500	4.8	90	8-15/64"	0.80	4.2	3/8"	92.0	2.8
QB-195-85	5"	8500	4.9	90	8-15/16"	1.40	5.3	3/8"	91.0	2.1
QB-195L-85	5"	8500	4.9	90	10-13/16"	1.40	5.5	3/8"	91.0	2.1
QB-195-120	5"	12000	5.1	90	8-15/16"	1.40	5.3	3/8"	91.0	2.1
QB-195L-120	5"	12000	5.1	90	10-13/16"	1.40	5.5	3/8"	91.0	2.1
QB-195CN	5"	12000	4.9	90	8-15/32"	1.00	4.4	3/8"	91.0	2.6
QB-623	2"	19000	8.1	90	6-5/16"	...	1.2	3/8"	80.0	0.5
QB-2925	2-1/2"x1/2"	16000	5.0	90	10-11/16"	0.90	2.9	3/8"	90.0	2.8
QB-2925L	2-1/2"x1/2"	16000	5.0	90	12-25/32"	0.90	3.0	3/8"	90.0	2.8









Uncertainty K=0.5a if a ≤ 5 m/s² or K=0.4a if a >5 m/s²

Référence	Diamètre du disque	Vitesse à vide	Cons. D'air moyenne	Pression	Longueur	Puissance du moteur	Poids	Tuyau d'air	Niveau sonore	Niveau de vibration
	mm	R.P.M	L/min	bar	mm	hp	kg	mm	dBA	m/s ²
Illustrator						hp				
QB-104	100	11000	170	6.3	226	0.78	1.81	10	87.8	1.2
QB-105	125	11000	170	6.3	226	0.78	1.81	10	87.1	1.2
QB-114	100	11000	170	6.3	230	0.78	1.81	10	87.8	1.2
QB-115	125	11000	170	6.3	230	0.78	1.81	10	87.1	1.2
QB-185	125	12000	170	6.3	232	1.40	2.80	13	86.0	2.1
QB-187	175	7000	170	6.3	247	2.00	4.00	13	86.0	2.1
QB-194	100	12000	138	6.3	215	0.90	1.90	10	91.0	2.6
QB-194L	100	12000	138	6.3	272	0.90	2.10	10	89.0	2.5
QB-194CN	100	13500	136	6.3	210	0.80	1.90	10	92.0	2.8
QB-195-85	125	8500	138	6.3	227	1.40	2.40	10	91.0	2.1
QB-195L-85	125	8500	138	6.3	275	1.40	2.50	10	91.0	2.1
QB-195-120	125	12000	144	6.3	227	1.40	2.40	10	91.0	2.1
QB-195L-120	125	12000	144	6.3	275	1.40	2.50	10	91.0	2.1
QB-195CN	125	12000	138	6.3	215	1.00	2.00	10	91.0	2.6
QB-623	50	19000	283	6.3	160	..	0.59	10	80.0	0.5
QB-2925	65x13	16000	141	6.3	270	0.90	1.33	10	90.0	2.8
QB-2925L	65x13	16000	141	6.3	324	0.90	1.39	10	90.0	2.8









Incertitude K=0.5a si a < 5m/s² ou K=0.4a si a > 5m/s²

Artikel-Nr.	Druckluft-Schleifer	Leerlauf Drehzahl	Luftverbrauch	Arbeitsdruck	Gesamtlänge	Motorleistung	Nettogewicht	Empf. Luftschlauch	Schalldruckpegel	Vibrationsniveau
	mm	R.P.M	L/min	bar	mm	kw	kg	mm	dBA	m/s ²
Illustrator						KW				
QB-104	100	11000	170	6.3	226	0.58	1.81	10	87.8	1.2
QB-105	125	11000	170	6.3	226	0.58	1.81	10	87.1	1.2
QB-114	100	11000	170	6.3	230	0.58	1.81	10	87.8	1.2
QB-115	125	11000	170	6.3	230	0.58	1.81	10	87.1	1.2
QB-185	125	12000	170	6.3	232	1.04	2.80	13	86.0	2.1
QB-187	175	7000	170	6.3	247	1.49	4.00	13	86.0	2.1
QB-194	100	12000	138	6.3	215	0.67	1.90	10	91.0	2.6
QB-194L	100	12000	138	6.3	272	0.67	2.10	10	89.0	2.5
QB-194CN	100	13500	136	6.3	210	0.60	1.90	10	92.0	2.8
QB-195-85	125	8500	138	6.3	227	1.00	2.40	10	91.0	2.1
QB-195L-85	125	8500	138	6.3	275	1.00	2.50	10	91.0	2.1
QB-195-120	125	12000	144	6.3	227	1.00	2.40	10	91.0	2.1
QB-195L-120	125	12000	144	6.3	275	1.00	2.50	10	91.0	2.1
QB-195CN	125	12000	138	6.3	215	0.75	2.00	10	91.0	2.6
QB-623	50	19000	283	6.3	160	..	0.57	10	80.0	0.5
QB-2925	65x13	16000	141	6.3	270	0.67	1.33	10	90.0	2.8
QB-2925L	65x13	16000	141	6.3	324	0.67	1.39	10	90.0	2.8









Unsicherheit K = 0.5, wenn ein $\leq 5 \text{ m/s}^2$ oder K = 0.4a, wenn $a > 5 \text{ m/s}^2$

Modelo	Disco	Velocidad libre	Consumo de Aire Promedio	Presión de Aire	Longitud Total	Motor	Peso Neto	Manguera de Aire	Presión Sonora	Nivel de vibración
	Inch	R.P.M	L/min	bar	mm	hp	kg	Inch	dBA	m/s ²
Illustrator						hp				
QB-104	4"	11000	170	6.3	226	0.78	1.81	10	87.8	1.2
QB-105	5"	11000	170	6.3	226	0.78	1.81	10	87.1	1.2
QB-114	4"	11000	170	6.3	230	0.78	1.81	10	87.8	1.2
QB-115	5"	11000	170	6.3	230	0.78	1.81	10	87.1	1.2
QB-185	5"	12000	170	6.3	232	1.40	2.80	13	86.0	2.1
QB-187	7"	7000	170	6.3	247	2.00	4.00	13	86.0	2.1
QB-194	4"	12000	138	6.3	215	0.90	1.90	10	91.0	2.6
QB-194L	4"	12000	138	6.3	272	0.90	2.10	10	89.0	2.5
QB-194CN	4"	13500	136	6.3	210	0.80	1.90	10	92.0	2.8
QB-195-85	5"	8500	138	6.3	227	1.40	2.40	10	91.0	2.1
QB-195L-85	5"	8500	138	6.3	275	1.40	2.50	10	91.0	2.1
QB-195-120	5"	12000	144	6.3	227	1.40	2.40	10	91.0	2.1
QB-195L-120	5"	12000	144	6.3	275	1.40	2.50	10	91.0	2.1
QB-195CN	5"	12000	138	6.3	215	1.00	2.00	10	91.0	2.6
QB-623	2"	19000	283	6.3	160	..	0.57	10	80.0	0.5
QB-2925	2-1/2"x1/2"	16000	141	6.3	270	0.90	1.33	10	90.0	2.8
QB-2925L	2-1/2"x1/2"	16000	141	6.3	324	0.90	1.39	10	90.0	2.8

variable K=0.5a si a ≤ 5 m/s² ó K=0.4a si a > 5 m/s²

Código	Diâmetro do disco	Velocidade Livre	Consumo de Ar	Pressão de operação	Comprimento Total	Potência do Motor	Peso	Diâmetro interno da mangueira	Nível de ruído	Nível de vibração
	Inch	R.P.M	L/min	PSI	mm	hp	kg	Inch	dBA	m/s ²
Illustrator						hp				
QB-104	4"	11000	170	90	226	0.78	1.81	3/8"	87.8	1.2
QB-105	5"	11000	170	90	226	0.78	1.81	3/8"	87.1	1.2
QB-114	4"	11000	170	90	230	0.78	1.81	3/8"	87.8	1.2
QB-115	5"	11000	170	90	230	0.78	1.81	3/8"	87.1	1.2
QB-185	5"	12000	170	90	232	1.40	2.80	1/2"	86.0	2.1
QB-187	7"	7000	170	90	247	2.00	4.00	1/2"	86.0	2.1
QB-194	4"	12000	138	90	215	0.90	1.90	3/8"	91.0	2.6
QB-194L	4"	12000	138	90	272	0.90	2.10	3/8"	89.0	2.5
QB-194CN	4"	13500	136	90	210	0.80	1.90	3/8"	92.0	2.8
QB-195-85	5"	8500	138	90	227	1.40	2.40	3/8"	91.0	2.1
QB-195L-85	5"	8500	138	90	275	1.40	2.50	3/8"	91.0	2.1
QB-195-120	5"	12000	144	90	227	1.40	2.40	3/8"	91.0	2.1
QB-195L-120	5"	12000	144	90	275	1.40	2.50	3/8"	91.0	2.1
QB-195CN	5"	12000	138	90	215	1.00	2.00	3/8"	91.0	2.6
QB-623	2"	19000	283	90	160	..	0.57	3/8"	80.0	0.5
QB-2925	2-1/2"x1/2"	16000	141	90	270	0.90	1.33	3/8"	90.0	2.8
QB-2925L	2-1/2"x1/2"	16000	141	90	324	0.90	1.39	3/8"	90.0	2.8

Incerteza K=0.5a se a $\leq 5 \text{ m/s}^2$ ou K=0,4a se a $> 5 \text{ m/s}^2$

Арт No.	Диаметр диска	Скорость свободн. Вращения	Среднее потребл. Воздуха	Рабочее давление воздуха	Общая длина	Мощность	Вес	Миним. Внутр. Д diam. Шланга	Уровень шума	Уровень вибрации
	mm	R.P.M	L/min	bar	mm	hp	kg	mm	dBA	m/s ²
Illustrator						hp				
QB-104	100	11000	170	6.3	226	0.78	1.81	10	87.8	1.2
QB-105	125	11000	170	6.3	226	0.78	1.81	10	87.1	1.2
QB-114	100	11000	170	6.3	230	0.78	1.81	10	87.8	1.2
QB-115	125	11000	170	6.3	230	0.78	1.81	10	87.1	1.2
QB-185	125	12000	170	6.3	232	1.40	2.80	13	86.0	2.1
QB-187	175	7000	170	6.3	247	2.00	4.00	13	86.0	2.1
QB-194	100	12000	138	6.3	215	0.90	1.90	10	91.0	2.6
QB-194L	100	12000	138	6.3	272	0.90	2.10	10	89.0	2.5
QB-194CN	100	13500	136	6.3	210	0.80	1.90	10	92.0	2.8
QB-195-85	125	8500	138	6.3	227	1.40	2.40	10	91.0	2.1
QB-195L-85	125	8500	138	6.3	275	1.40	2.50	10	91.0	2.1
QB-195-120	125	12000	144	6.3	227	1.40	2.40	10	91.0	2.1
QB-195L-120	125	12000	144	6.3	275	1.40	2.50	10	91.0	2.1
QB-195CN	125	12000	138	6.3	215	1.00	2.00	10	91.0	2.6
QB-623	50	19000	283	6.3	160	..	0.57	10	80.0	0.5
QB-2925	65x13	16000	141	6.3	270	0.90	1.33	10	90.0	2.8
QB-2925L	65x13	16000	141	6.3	324	0.90	1.39	10	90.0	2.8

Погрешность K=0.5a, если a ≤ 5 m/s² или K=0.4a если a > 5 m/s²



EC DECLARATION OF CONFORMITY

Original Language

Serial Number: Please refer to the tool

Air Angle Grinder

Item No.: QB-104 QB-105 QB-114 QB-115 QB-124 QB-125 QB-134 QB-135
QB-107 QB-117 QB-185 QB-187 QB-194 QB-194L QB-194CN QB-195-85
QB-195L-85 QB-195-120 QB-195L-120 QB-195CN QB-623 QB-2925 QB-2925L

We declare under our own responsibility that the above machinery fulfils all the relevant provisions of Machinery Directive 2006/42/EC and its amendment and is manufactured and tested according to the following standards:

EN 792-7 / EN ISO 15744 / EN 28662-1 and EN ISO 8662-4

Declared in: Taichung, Taiwan

Dated:01/06/2015

Signature

Jonney Chen

Declared by: QA Manager



Manufacturer:

Mighty Seven International Co., Ltd.

No. 70-25,Ching Cunag Rd., Wu-Jih Shiang,

Taichung Hsien, 41466 Taiwan

www.mighty-seven.com

Authorized contact, to compile the technical files :

King Tony France

3 Rue des imprimeurs ZI République Nord 1.

86000 POITIERS FRANCE

TEL : (+33) 5-49-30-30-90

E-MAIL : christian.aubineau@kingtony.eu



EC-DECLARATION DE CONFORMITE

traduit de la langue originale

Numéro de série : se référer au numéro inscrit sur la machine

Meuleuse d'angle

Référence: QB-104 QB-105 QB-114 QB-115 QB-124 QB-125 QB-134 QB-135
QB-107 QB-117 QB-185 QB-187 QB-194 QB-194L QB-194CN QB-195-85
QB-195L-85 QB-195-120 QB-195L-120 QB-195CN QB-623 QB-2925 QB-2925L

Nous déclarons sous notre propre responsabilité que les outils sus mentionnés sont conformes aux provisions relative à la directive outillage 2006/42/EC et ses amendements

et qu'ils ont été fabriqués et testés selon les standards suivants :

EN 792-7 / EN ISO 15744 / EN 28662-1 and EN ISO 8662-4

Déclaré à: Taichung, Taiwan

Dated:01/06/2015

Signature

Jonney Chen

Declared by: QA Manager



Fabricant:

Mighty Seven International Co., Ltd.

No. 70-25,Ching Qunag Rd., Wu-Jih Shiang,

Taichung Hsien, 41466 Taiwan

www.mighty-seven.com

Personne autorisée pour établir les fiches techniques:

King Tony France

3 Rue des imprimeurs ZI République Nord 1. 86000 POITIERS

FRANCE

TEL : (+33) 5-49-30-30-90

E-MAIL : christian.aubineau@kingtony.eu



EG-Konformitätserklärung

Übersetzung aus der Original-Sprache

Seriennummer: bitte bei Frage immer angeben!

Druckluft-Schleifer

Artikel-Nr. QB-104 QB-105 QB-114 QB-115 QB-124 QB-125 QB-134 QB-135
QB-107 QB-117 QB-185 QB-187 QB-194 QB-194L QB-194CN QB-195-85
QB-195L-85 QB-195-120 QB-195L-120 QB-195CN QB-623 QB-2925 QB-2925L

Wir erklären in eigener Verantwortung, dass folgendes Produkt alle einschlägigen Bestimmungen der Maschinen-Richtlinie 2006/42/EC erfüllt und deren Änderungen, und dass es hergestellt wird und nach den folgenden Normen geprüft wird:

EN 792-7 / EN ISO 15744 / EN 28662-1 and EN ISO 8662-4

Erklärt in: Taichung, Taiwan

Datum: 01/06/2015

Unterschrift:

Jonney Chen

Erklärt von: QA Manager



Der Hersteller:

Mighty Seven International Co., Ltd.

No. 70-25, Ching Cunag Rd., Wu-Jih Shiang,

Taichung Hsien, 41466 Taiwan

www.mighty-seven.com

Autorisierte Person, die zur Erstellung des technischen

Dossiers ist :

King Tony France

3 Rue des imprimeurs ZI République Nord 1.

86000 POITIERS FRANCE

TEL : (+33) 5-49-30-30-90

E-MAIL : christian.aubineau@kingtony.eu



DECLARACIÓN DE CONFORMIDAD DE EC

Traducción del lenguaje original

Número de serie: por favor ver la herramienta

Amoladora Angular Neumática

Modelo : QB-104 QB-105 QB-114 QB-115 QB-124 QB-125 QB-134 QB-135
QB-107 QB-117 QB-185 QB-187 QB-194 QB-194L QB-194CN QB-195-85
QB-195L-85 QB-195-120 QB-195L-120 QB-195CN QB-623 QB-2925 QB-2925L

Declaramos bajo nuestra propia responsabilidad que la maquinaria arriba mencionada cumple con todas las provisiones relevantes de la Directiva de Maquinaria 2006/42/EC y sus enmiendas y ha sido fabricado y probado de acuerdo a los siguientes estándares:

EN 792-7 / EN ISO 15744 / EN 28662-1 and EN ISO 8662-4

Declarado en: Taichung, Taiwan

Fecha: 01/06/2015

Firma

Jonney Chen

Declarado por: Gerente de Control de Calidad



Fabricante:

Mighty Seven International Co., Ltd.

No. 70-25, Ching Quang Rd., Wu-Jih Shiang,

Taichung Hsien, 41466 Taiwan

www.mighty-seven.com

Contacto Autorizado, para recopilar los archivos técnicos :

King Tony France

3 Rue des imprimeurs ZI République Nord 1. 86000 POITIERS

FRANCE

TEL : (+33) 5-49-30-30-90

E-MAIL : christian.aubineau@kingtony.eu



Declaração de Conformidade EC

tradução da língua original

número de série: por favor, procure-o na ferramenta

Esmerilhadeira angular pneumática

Código.: QB-104 QB-105 QB-114 QB-115 QB-124 QB-125 QB-134 QB-135

QB-107 QB-117 QB-185 QB-187 QB-194 QB-194L QB-194CN QB-195-85

QB-195L-85 QB-195-120 QB-195L-120 QB-195CN QB-623 QB-2925 QB-2925L

Declaramos bajo nuestra propia responsabilidad que la maquinaria arriba mencionada cumple con todas las provisiones relevantes de la Directiva de Maquinaria 2006/42/EC y sus enmiendas y ha sido fabricado y probado de acuerdo a los siguientes estándares:

EN 792-7 / EN ISO 15744 / EN 28662-1 and EN ISO 8662-4

Declarada em: Taichung, Taiwan

Data da de: 01/06/2015

Assinada por

Jonney Chen

Declarada pelo Gerente da Qualidade



Fabricante:

Mighty Seven International Co., Ltd.

No. 70-25, Ching Quag Rd., Wu-Jih Shiang,

Taichung Hsien, 41466 Taiwan

www.mighty-seven.com

Contato responsável pelas informações técnicas:

King Tony France

3 Rue des imprimeurs ZI République Nord 1. 86000 POITIERS

FRANCE

TEL : (+33) 5-49-30-30-90

E-MAIL : christian.aubineau@kingtony.eu

CE



Air Angle Grinder

Item No : QB-104

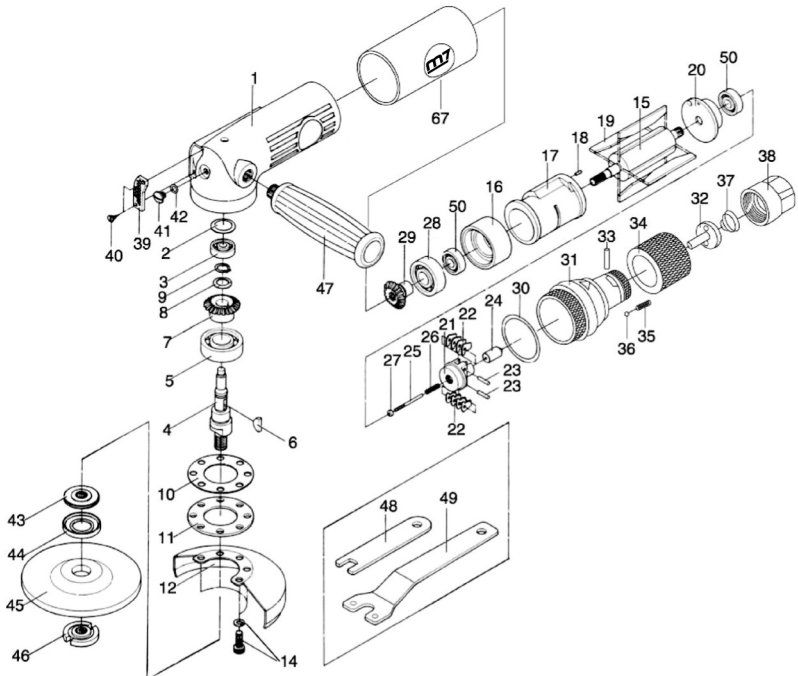

Part List

Roll Type Throttle
Item No : QB-104



NO.	INDEX NO.	DESCRIPTION	Q'TY
01	QB-104P01	Motor Housing	1
02	QB-104P02	Seal Plate	1
03	QB-104P03	Ball Bearing	1
04	QB-104P04	Arbor	1
05	QB-104P05	Ball Bearing	1
06	QB-104P06	Woodruff Key	1
07	---	Bevel Gear	1
08	QB-104P08	Wave Washer	1
09	QB-104P09	External Stop Ring	1
10	QB-104P10	Gasket	1
11	QB-104P11	Retainer	1
12	QB-104P12	Wheel Guard	1
14	QB-104T14	Cap Bolt (5 pcs)	1 set
15	QB-104P15	Rotor	1
16	QB-104P16	Front End Plate	1
17	QB-104P17	Cylinder	1
18	QB-104P18	Spring Pin	1
19	QB-104T19	Rotor Blade (4 pcs)	1 set
20	QB-104P20	Rear End Plate	1
21	---	Governor	1
22	---	Pendulum	8
23	---	Spring Pin	2
24	---	Plunger	1
25	---	Adjust Screw	1
26	---	Spring	1
27	---	Adjust Nut	1
28	QB-104P28	Ball Bearing	1
29	---	Bevel Pinion	1
30	QB-104P30	O-Ring	1
31	QB-104P31	Governor Housing	1
32	QB-104P32	Valve Stem	1
33	QB-104P33	Roller Pin	1
34	QB-104P34	Valve Ring	1
35	QB-104P35	Valve Spring	1
36	QB-104P36	Steel Ball	1
37	QB-104P37	Coil Spring	1
38	QB-104P38	Air Inlet Joint	1
39	QB-104P39	Exhaust Deflector	1
40	QB-104T40	Tapping Screw (2 pcs)	1 set
41	QB-104P41	Grease Inlet Plug	1
42	QB-104P42	O-Ring	1
43	QB-104P43	Wheel Flange	1
44	QB-104P44	Rubber Shield	1
45	QB-104P45	Grinding Wheel	1
46	QB-104P46	Wheel Clamp	1
47	QB-104P47	Handle	1
48	QB-104P48	Wheel Wrench (A)	1
49	QB-104P49	Wheel Wrench (B)	1
50	QB-104T50	Ball Bearing (2 pcs)	1 set
67	QB-104P67	Grip	1
	QB-104T01	Governor Assembly (21.22.23.24.25.26.27)	1set
	QB-104T02	Bevel Gear Assembly (07.29)	1set



Air Angle Grinder

Item No : QB-105

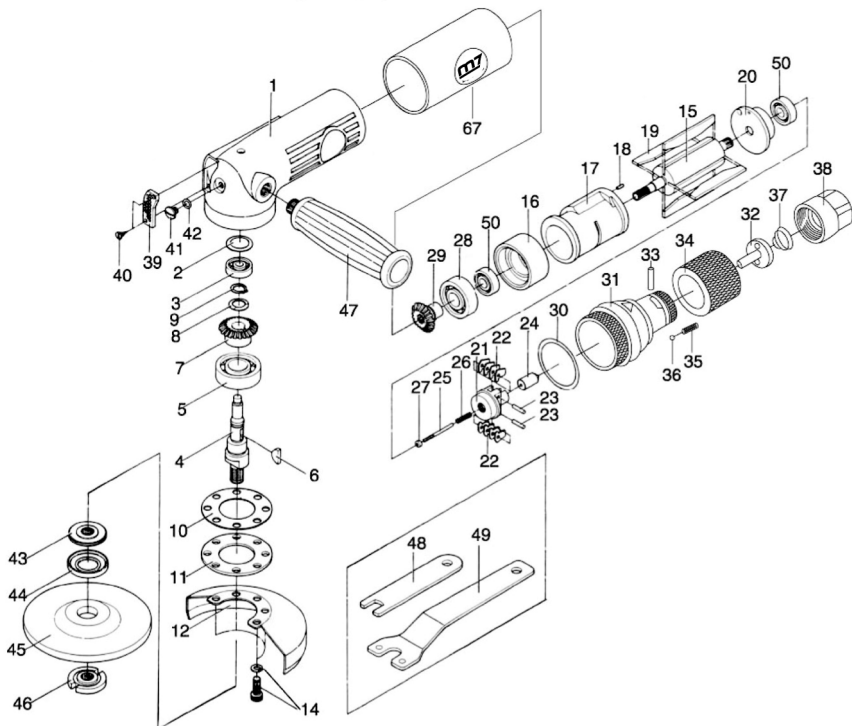

Part List

Roll Type Throttle
Item No : QB-105



NO.	INDEX NO.	DESCRIPTION	Q'TY
01	QB-105P01	Motor Housing	1
02	QB-105P02	Seal Plate	1
03	QB-105P03	Ball Bearing	1
04	QB-105P04	Arbor	1
05	QB-105P05	Ball Bearing	1
06	QB-105P06	Woodruff Key	1
07	---	Bevel Gear	1
08	QB-105P08	Wave Washer	1
09	QB-105P09	Retaining Ring	1
10	QB-105P10	Gasket	1
11	QB-105P11	Retainer	1
12	QB-105P12	Wheel Guard	1
14	QB-105T14	Cap Bolt (5 pcs)	1 set
15	QB-105P15	Rotor	1
16	QB-105P16	Front End Plate	1
17	QB-105P17	Cylinder	1
18	QB-105P18	Spring Pin	1
19	QB-105T19	Rotor Blade (4 pcs)	1 set
20	QB-105P20	Rear End Plate	1
21	---	Governor	1
22	---	Pendulum (8 pcs)	8
23	---	Spring Pin (2 pcs)	2
24	---	Plunger	1
25	---	Adjust Screw	1
26	---	Spring	1
27	---	Adjust Nut	1
28	QB-105P28	Ball Bearing	1
29	---	Bevel Pinion	1
30	QB-105P30	O-Ring	1
31	QB-105P31	Governor Housing	1
32	QB-105P32	Valve Clamp	1
33	QB-105P33	Roller Pin	1
34	QB-105P34	Valve Ring	1
35	QB-105P35	Valve Spring	1
36	QB-105P36	Steel Ball	1
37	QB-105P37	Coil Spring	1
38	QB-105P38	Air Inlet Joint	1
39	QB-105P39	Exhaust Deflector	1
40	QB-105T40	Tapping Screw (2 pcs)	1 set
41	QB-105P41	Grease Inlet Plug	1
42	QB-105P42	O-Ring	1
43	QB-105P43	Wheel Flange	1
44	QB-105P44	Rubber Shield	1
45	QB-105P45	Grinding Wheel	1
46	QB-105P46	Wheel Clamp	1
47	QB-105P47	Handle	1
48	QB-105P48	Wheel Wrench (A)	1
49	QB-105P49	Wheel Wrench (B)	1
50	QB-105T50	Ball Bearing (2 pcs)	1 set
67	QB-105P67	Grip	1
	QB-105T01	Governor Assembly (21.22.23.24.25.26.27)	1 set
	QB-105T02	Bevel Gear Assembly (07.29)	1 set



Air Angle Grinder

Item No : QB-114

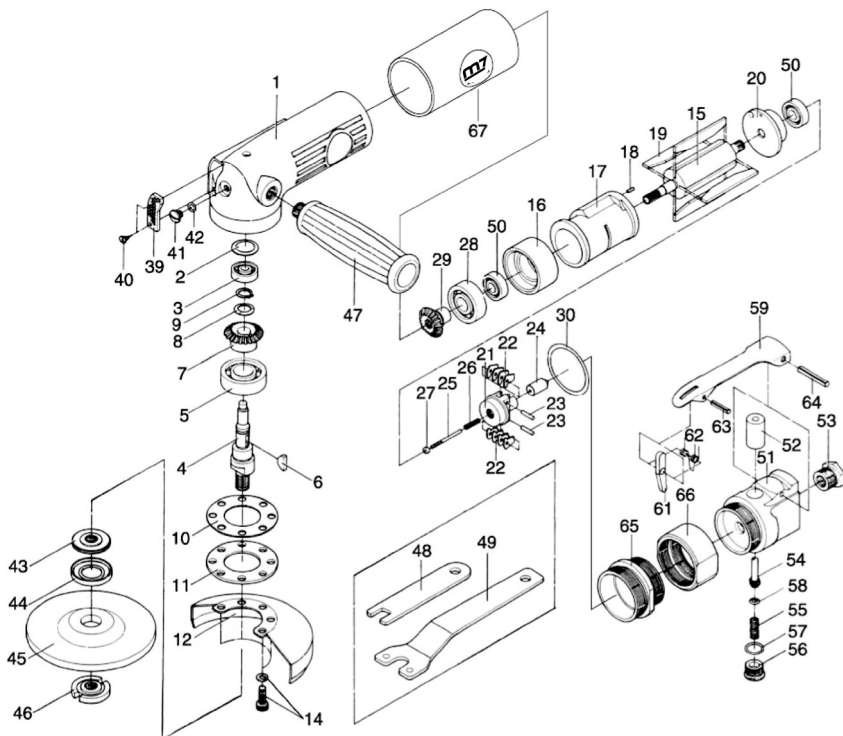

Part List

Lever Type Throttle
Item No : QB-114



NO.	INDEX NO.	DESCRIPTION	Q'TY	NO.	INDEX NO.	DESCRIPTION	Q'TY
01	QB-114P01	Motor Housing	1	48	QB-114P48	Wheel Wrench (A)	1
02	QB-114P02	Seal Plate	1	49	QB-114P49	Wheel Wrench (B)	1
03	QB-114P03	Ball Bearing (626z)	1	50	QB-114T50	Ball Bearing (2pcs) (608z)	1 set
04	QB-114P04	Arbor	1	51	---	Throttle Housing	1
05	QB-114P05	Ball Bearing (6202z)	1	52	---	Throttle Bushing	1
06	QB-114P06	Woodruff Key	1	53	---	Inlet Bushing	1
07	---	Bevel Gear	1	54	QB-114P54	Valve Stem	1
08	QB-114P08	Wave Washer	1	55	QB-114P55	Valve Spring	1
09	QB-114P09	Retaining Ring	1	56	QB-114P56	Throttle Lever Plug	1
10	QB-114P10	Gasket	1	57	---	O-Ring	1
11	QB-114P11	Retainer	1	58	---	O-Ring	1
12	QB-114P12	Wheel Guard	1	59	---	Throttle Lever	1
14	QB-114T14	Cap Bolt (5pcs)	1 set	61	---	Safety Lever	1
15	QB-114P15	Rotor	1	62	---	Torsion Spring	1
16	QB-114P16	Front End Plate	1	63	---	Spring Pin	1
17	QB-114P17	Cylinder	1	64	QB-114P64	Spring Pin	1
18	QB-114P18	Spring Pin	1	65	QB-114P65	Lock Ring	1
19	QB-114T19	Rotor Blade (4pcs)	1 set	66	QB-114P66	Coupling Nut	1
20	QB-114P20	Rear End Plate	1	67	QB-114P67	Grip	1
21	---	Governor	1		QB-114T01	Throttle Housing Assembly (51.52.53)	1 set
22	---	Pendulum	8		QB-114T02	Throttle Lever Assembly (59.61.62.63)	1 set
23	---	Spring Pin	2		QB-114T03	Governor Assembly (21.22.23.24.25.26.27)	1 set
24	---	Plunger	1		QB-114T04	Bevel Gear Assembly (07.29)	1 set
25	---	Adjust Screw	1		QB-114T05	O-ring Assembly (57.58)	1 set
26	---	Spring	1				
27	---	Adjust Nut	1				
28	QB-114P28	Ball Bearing (6201z)	1				
29	---	Bevel Pinion	1				
30	QB-114P30	O-Ring	1				
39	QB-114P39	Exhaust Deflector	1				
40	QB-114T40	Taping Screw (2 pcs)	1 set				
41	QB-114P41	Grease Inlet Plug	1				
42	QB-114P42	O-Ring	1				
43	QB-114P43	Wheel Flange	1				
44	QB-114P44	Rubber Shield	1				
45	QB-114P45	Grinding Wheel	1				
46	QB-114P46	Wheel Clamp	1				
47	QB-114P47	Handle	1				



Air Angle Grinder

Item No : QB-115

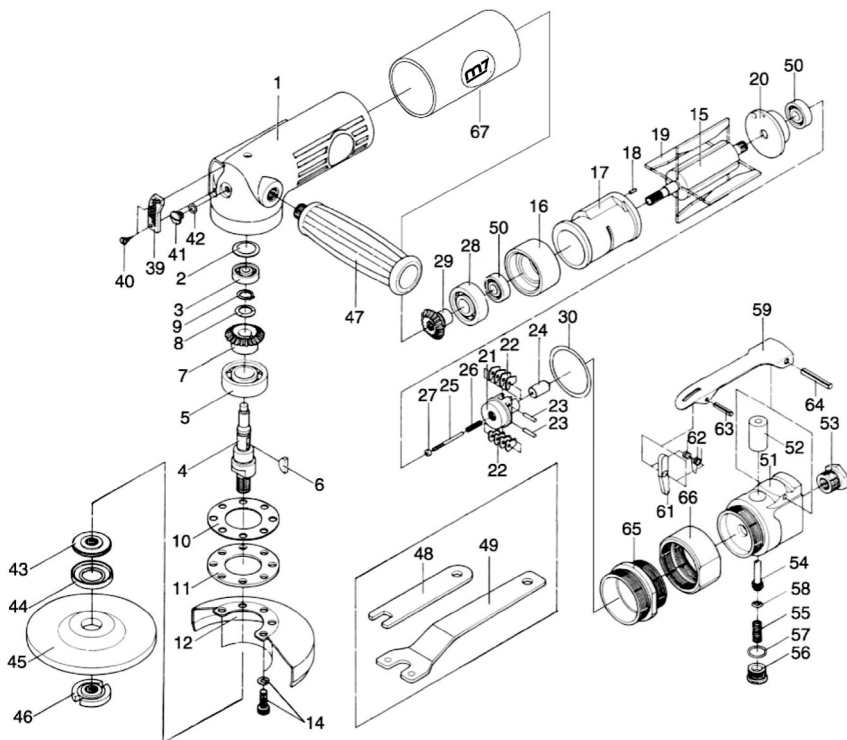

Part List

Lever Type Throttle
Item No : QB-115



NO.	INDEX NO.	DESCRIPTION	Q'TY	NO.	INDEX NO.	DESCRIPTION	Q'TY
01	QB-115P01	Motor Housing	1	48	QB-115P48	Wheel Wrench (A)	1
02	QB-115P02	Seal Plate	1	49	QB-115P49	Wheel Wrench (B)	1
03	QB-115P03	Ball Bearing	1	50	QB-115T50	Ball Bearing (2 pcs)	1 set
04	QB-115P04	Arbor	1	51	---	Throttle Housing	1
05	QB-115P05	Ball Bearing	1	52	---	Throttle Bushing	1
06	QB-115P06	Woodruff Key	1	53	---	Inlet Bushing	1
07	---	Bevel Gear	1	54	QB-115P54	Valve Stem	1
08	QB-115P08	Wave Washer	1	55	QB-115P55	Valve Spring	1
09	QB-115P09	Retaining Ring	1	56	QB-115P56	Throttle Lever Plug	1
10	QB-115P10	Gasket	1	57	---	O-Ring	1
11	QB-115P11	Retainer	1	58	---	O-Ring	1
12	QB-115P12	Center Wheel Guard	1	59	---	Throttle Lever	1
14	QB-115T14	Cap Bolt (5pcs)	1 set	61	---	Safety Lever	1
15	QB-115P15	Rotor	1	62	---	Torsion Spring	1
16	QB-115P16	Front End Plate	1	63	---	Spring Pin	1
17	QB-115P17	Cylinder	1	64	QB-115P64	Spring Pin	1
18	QB-115P18	Spring Pin	1	65	QB-115P65	Lock Ring	1
19	QB-115T19	Rotor Blade (4 pcs)	1 set	66	QB-115P66	Coupling Nut	1
20	QB-115P20	Rear End Plate	1	67	QB-115P67	Grip	1
21	---	Governor	1				
22	---	Pendulum	8		QB-115T01	Throttle Housing Assembly (51.52.53)	1 set
23	---	Spring Pin	2				
24	---	Plunger	1		QB-115T02	Throttle Lever Assembly (59.61.62.63)	1 set
25	---	Adjust Screw	1				
26	---	Spring	1		QB-115T03	Governor Assembly (21.22.23.24.25.26.27)	1 set
27	---	Adjust Nut	1				
28	QB-115P28	Ball Bearing	1		QB-115T04	Bevel Gear Assembly (07.29)	1 set
29	---	Bevel Pinion	1		QB-115T05	O-ring Assembly (57.58)	1 set
30	QB-115P30	O-Ring	1				
39	QB-115P39	Exhaust Deflector	1				
40	QB-115T40	Tapping Screw (2 pcs)	1 set				
41	QB-115P41	Grease Inlet Plug	1				
42	QB-115P42	O-Ring	1				
43	QB-115P43	Wheel Flange	1				
44	QB-115P44	Rubber Shield	1				
45	QB-115P45	Grinding Wheel	1				
46	QB-115P46	Wheel Clamp	1				
47	QB-115P47	Handle	1				



Vertical Grinders

Item No : QB-185

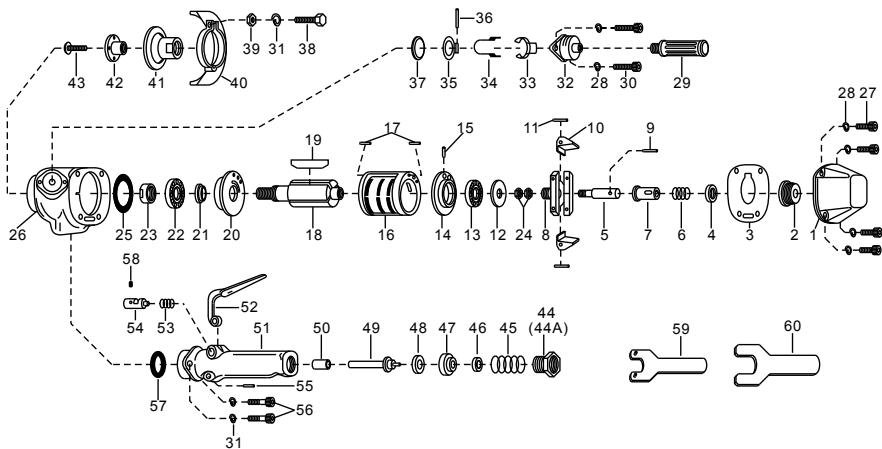

Part List

Lever Type Throttle
Item No : QB-185



No.	Part No.	Description	Q'ty
1	QB-185P01	Housing Cover	1
2	QB-185P02	Bushing	1
3	QB-185P03	Packing	1
4	QB-185P04	Governor Valve Spring Holder	1
5	QB-185P05	Governor Shaft	1
6	QB-185P06	Governor Valve Spring	1
7	QB-185P07	Governor Valve	1
8	QB-185P08	Governor Cage	1
9	QB-185P09	Needle Roller	1
10	QB-185T10	Governor Weight (2pcs)	1 SET
11	QB-185T11	Governor Pin (2pcs)	1 SET
12	QB-185P12	Bearing Cover	1
13	QB-185P13	Ball Bearing (BB-6202MN)	1
14	QB-185P14	Cylinder Upper Plate	1
15	QB-185P15	Spring Pin	1
16	QB-185P16	Cylinder	1
17	QB-185T17	Spring Pin (2pcs)	1 SET
18	QB-185P18	Rotor	1
19	QB-185T19	Rotor Blade (4pcs)	1 SET
20	QB-185P20	Cylinder Lower Plate	1
21	QB-185P21	Adjusting collar	1
22	QB-185P22	Ball Bearing	1
23	QB-185P23	Rotor Nut	1
24	QB-185T24	Nut (2pcs)	1 SET
25	QB-185P25	Adjusting Washer(T=0.2)	1
26	QB-185P26	Housing	1
27	QB-185P27	Cap Screw	1
28	QB-185T28	Spring Washer (6pcs)	1 SET
29	QB-185P29	Dead Dandle	1
30	QB-185T30	Cap Screw (2pcs)	1 SET
31	QB-185T31	Spring Washer (3pcs)	1 SET

No.	Part No.	Description	Q'ty
32	QB-185P32	Exhaust Cover	1
33	QB-185P33	Muffler Plate Holder	1
34	QB-185P34	Muffler Spring	1
35	QB-185P35	Muffler Plate	1
36	QB-185P36	Spring Pin	1
37	QB-185P37	Exhaust Valve	1
38	QB-185P38	Hexagon Bolt	1
39	QB-185P39	Nut	1
40	QB-185P40	Wheel Guard	1
41	QB-185P41	Wheel Flange	1
42	QB-185P42	Wheel Flange	1
43	QB-185P43	Cap Screw	1
44	QB-185P44	Inlet Bushing (PT)	1
44A	QB-185P44A	Inlet Bushing (NPT)	1
45	QB-185P45	Throttle Valve Spring	1
46	QB-185P46	Sub Throttle Valve	1
47	QB-185P47	Throttle Valve Washer	1
48	QB-185P48	Throttle Valve	1
49	QB-185P49	Throttle Valve Rod	1
50	QB-185P50	Throttle Valve Rod Bushing	1
51	QB-185P51	Throttle Valve Body	1
52	QB-185P52	Throttle Valve Lever	1
53	QB-185P53	Lock Spring	1
54	QB-185P54	Lock Key	1
55	QB-185P55	Grooved Pin	1
56	QB-185T56	Cap Screw (2pcs)	1 SET
57	QB-185P57	O-Ring	1
58	QB-185P58	Set Screw	1
59	QB-185P59	Spanner	1
60	QB-185P60	Spanner	1



Vertical Grinders

Item No : QB-187

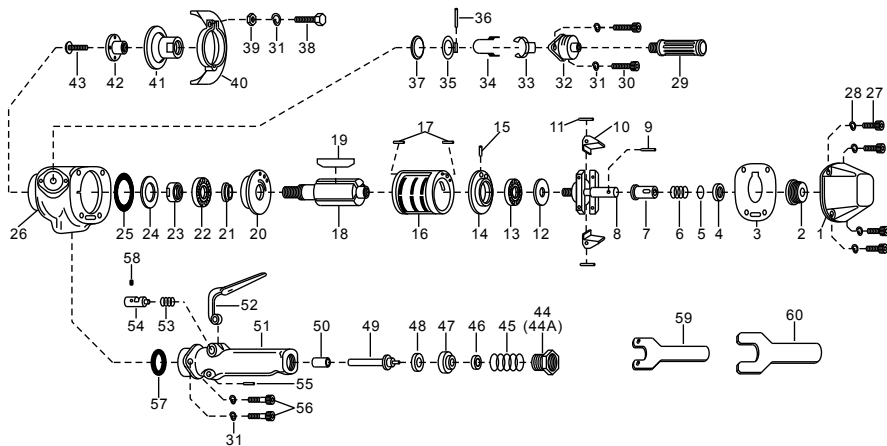

Part List

Lever Type Throttle
Item No : QB-187



No.	Part No.	Description	Q'ty
1	QB-187P01	Housing Cover	1
2	QB-187P02	Bushing	1
3	QB-187P03	Packing	1
4	QB-187P04	Governor Valve Spring Holder	1
5	QB-187P05	Governor Shaft (T=0.2)	1
6	QB-187P06	Governor Valve Spring	1
7	QB-187P07	Governor Valve	1
8	QB-187P08	Governor Cage	1
9	QB-187P09	Needle Roller	1
10	QB-187T10	Governor Weight (2pcs)	1 SET
11	QB-187T11	Governor Pin (2pcs)	1 SET
12	QB-187P12	Bearing Cover	1
13	QB-187P13	Ball Bearing (BB-6202MN)	1
14	QB-187P14	Cylinder Upper Plate	1
15	QB-187P15	Spring Pin	1
16	QB-187P16	Cylinder	1
17	QB-187T17	Spring Pin (2pcs)	1 SET
18	QB-187P18	Rotor	1
19	QB-187T19	Rotor Blade (4pcs)	1 SET
20	QB-187P20	Cylinder Lower Plate	1
21	QB-187P21	Adjusting collar	1
22	QB-187P22	Ball Bearing (BB-6303)	1
23	QB-187P23	Rotor Nut	1
24	QB-187P24	Bearing Spacer	1
25	QB-187P25	Adjusting Washer (T=0.2)	1
26	QB-187P26	Housing	1
27	QB-187P27	Cap Screw	1
28	QB-187T28	Spring Washer (6pcs)	1 SET
29	QB-187P29	Dead Handle	1
30	QB-187T30	Cap Screw (2pcs)	1 SET
31	QB-187T31	Spring Washer (3pcs)	1 SET

No.	Part No.	Description	Q'ty
32	QB-187P32	Exhaust Cover	1
33	QB-187P33	Muffler Plate Holder	1
34	QB-187P34	Muffler Spring	1
35	QB-187P35	Muffler Plate	1
36	QB-187P36	Spring Pin	1
37	QB-187P37	Exhaust Valve	1
38	QB-187P38	Hexagon Bolt	1
39	QB-187P39	Nut	1
40	QB-187P40	Wheel Guard	1
41	QB-187P41	Wheel Flange	1
42	QB-187P42	Wheel Flange	1
43	QB-187P43	Cap Screw	1
44	QB-187P44	Inlet Bushing (PT)	1
44A	QB-187P44A	Inlet Bushing (NPT)	1
45	QB-187P45	Throttle Valve Spring	1
46	QB-187P46	Sub Throttle Valve	1
47	QB-187P47	Throttle Valve Washer	1
48	QB-187P48	Throttle Valve	1
49	QB-187P49	Throttle Valve Rod	1
50	QB-187P50	Throttle Valve Rod Bushing	1
51	QB-187P51	Throttle Valve Body	1
52	QB-187P52	Throttle Valve Lever	1
53	QB-187P53	Lock Spring	1
54	QB-187P54	Lock Key	1
55	QB-187P55	Grooved Pin	1
56	QB-187T56	Cap Screw (2pcs)	1 SET
57	QB-187P57	O-Ring (S34)	1
58	QB-187P58	Set Screw	1
59	QB-187P59	Spanner	1
60	QB-187P60	Spanner	1



Air Angle Grinder

Item No : QB-194 / QB-194L

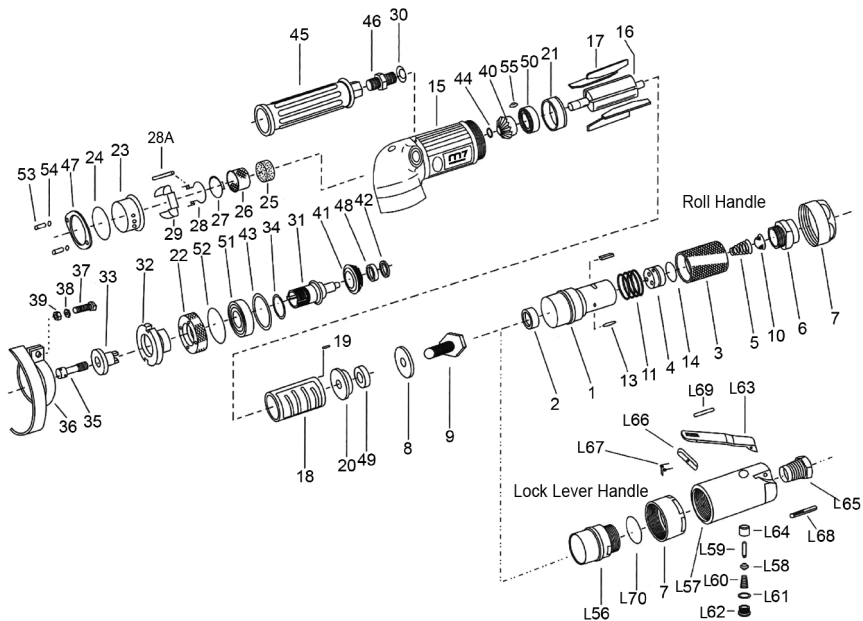

Part List

Item No : QB-194
: QB-194L



No.	Part No.	Description	Qty
1	QB-194P01	Housing Cover	1
2	QB-194P02	Bushing	1
3	QB-194P03	Throttle Valve Handle	1
4	QB-194P04	Throttle Valve	1
5	QB-194P05	Throttle Valve Spring	1
6	QB-194P06	Throttle Valve Cover	1
7	QB-194P07	Cup Nut	1
8	QB-194P08	Top plate Washer	1
9	QB-194P09	Lock Screw	1
10	QB-194P10	Strainer	1
11	QB-194P11	Throttle Valve Handle Spring	1
12	QB-194P12	Needle Roller 3*12	1
13	QB-194P13	Needle Roller 4*15	1
14	QB-194P14	O Ring S20	1
15	QB-194P15	Housing	1
16	QB-194P16	Rotor	1 SET
17	QB-194T17	Rotor Blade (4PCS)	1 SET
18	QB-194P18	Cylinder	1
19	QB-194P19	Spring Pin 2*6	1
20	QB-194P20	Cylinder Upper Plate	1
21	QB-194P21	Cylinder Lower Plate	1
22	QB-194P22	Spindle Bearing Cover	1
23	QB-194P23	Exhaust Cover	1
24	QB-194P24	O Ring S40	1
25	QB-194P25	Muffler Pad	1
26	QB-194P26	Strainer	1
27	QB-194P27	Muffler Plate	1
28	QB-194P28	Muffler Spring	1
28A	QB-194P28A	Spring Pin	1
29	QB-194P29	Muffler Plate Holder	1
30	QB-194P30	Conical Spring Washer	1
31	QB-194P31	Wheel Spindle	1
32	QB-194P32	Wheel Flange A	1
33	QB-194P33	Wheel Flange B	1
34	QB-194P34	Wheel Spindle Washer	1
35	QB-194P35	Detent Bolt	1

No.	Part No.	Description	Qty
36	QB-194P36	Wheel Guard	1
37	QB-194P37	Hexagon Bolt	1
38	QB-194P38	Spring Washer	1
39	QB-194P39	Nut	1
40	QB-194P40	Bevel Pinion	1
41	QB-194P41	Bevel Gear	1
42	QB-194P42	Bearing Washer	1
43	QB-194P43	Bearing Washer	1
44	QB-194P44	Ring	1
45	QB-194P45	Dead Handle	1
46	QB-194P46	Dead Handle Joint	1
47	QB-194P47	Exhaust Cover Holder	1
48	QB-194P48	Ball Bearing 626	1
49	QB-194P49	Ball Bearing 609	1
50	QB-194P50	Ball Bearing 6200	1
51	QB-194P51	Ball Bearing 6004	1
52	QB-194P52	O Ring	1
53	QB-194T53	Cap Screw (2PCS)	1 SET
54	QB-194T54	Spring Washer (2PCS)	1 SET
55	QB-194P55	Key	1
L56	QB-194LP56	Housing Cover	1
L57	QB-194LP57	Handle	1
L58	QB-194LP58	Throttle Valve	1
L59	QB-194LP59	Throttle Pin	1
L60	QB-194LP60	Throttle Valve Spring	1
L61	QB-194LP61	T.V. Cover Packing	1
L62	QB-194LP62	Throttle Valve Cover	1
L63	QB-194LP63	Lever	1
L64	QB-194LP64	Throttle Valve Rod Bushing	1
L65	QB-194LP65	Inlet Bushing	1
L66	QB-194LP66	Lock Key	1
L67	QB-194LP67	Lock Spring	1
L68	QB-194LP68	Spring Pin	1
L69	QB-194LP69	Spring Pin	1
L70	QB-194LP70	O Ring	1



Air Angle Grinder

Item No : QB-194-CN

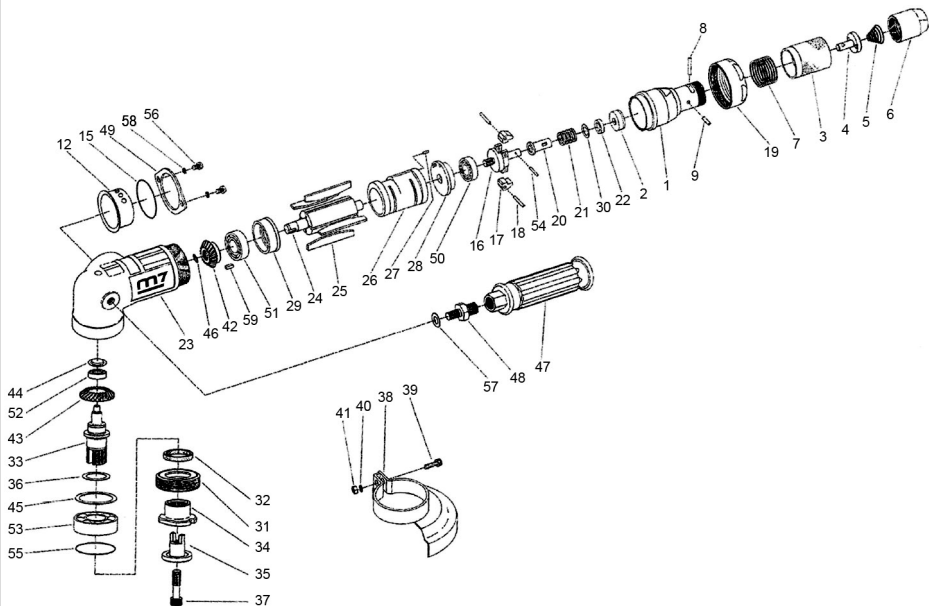

Part List

Roll Type Throttle
Item No : QB-194-CN



No.	Part No.	Description	Q'ty
1	QB-194-CNP01	Housing Cover	1
2	QB-194-CNP02	Bushing	1
3	QB-194-CNP03	Throttle Valve Handle	1
4	QB-194-CNP04	Throttle Valve	1
5	QB-194-CNP05	Throttle Valve Spring	1
6	QB-194-CNP06	Throttle Valve Cover	1
7	QB-194-CNP07	Throttle Valve Handle Spring	1
8	QB-194-CNP08	Needle Roller 3*12	1
9	QB-194-CNP09	Needle Roller 4*15	1
10	QB-194-CNP10	Strainer	1
11	QB-194-CNP11	Muffler	1
12	QB-194-CNP12	Exhaust Cover	1
13	QB-194-CNP13	Muffler Plate	1
14	QB-194-CNP14	Muffler Spring	1
15	QB-194-CNP15	O Ring	1
16	QB-194-CNP16	Top plate Washer	1
17	QB-194-CNT17	Lock Screw (2PCS)	1 SET
18	QB-194-CNT18	Spring Pin (2PCS)	1 SET
19	QB-194-CNP19	Cup Nut	1
20	QB-194-CNP20	Regulator	1
21	QB-194-CNP21	Spring	1
22	QB-194-CNP22	Bushing	1
22A	QB-194-CNP22A	Screw	1
23	QB-194-CNP23	Housing	1
24	QB-194-CNP24	Rotor	1
25	QB-194-CNT25	Rotor Blade (4PCS)	1 SET
26	QB-194-CNP26	Cylinder	1
27	QB-194-CNP27	Spring Pin	1
28	QB-194-CNP28	Cylinder Upper Plate	1
29	QB-194-CNP29	Cylinder Lower Plate	1
30	QB-194-CNP30	Adjusting Washer	1

No.	Part No.	Description	Q'ty
31	QB-194-CNP31	Spindle Bearing Cover	1
32	QB-194-CNP32	Felt Ring	1
33	QB-194-CNP33	Wheel Spindle	1
34	QB-194-CNP34	Wheel Flange A	1
35	QB-194-CNP35	Wheel Flange B	1
36	QB-194-CNP36	Wheel Spindle Washer	1
37	QB-194-CNP37	Detent Bolt	1
38	QB-194-CNP38	Wheel Guard	1
39	QB-194-CNP39	Bolt	1
40	QB-194-CNP40	Spring Washer	1
41	QB-194-CNP41	Nut	1
42	QB-194-CNP42	Bevel Pinion	1
43	QB-194-CNP43	Bevel Gear	1
44	QB-194-CNP44	Bearing Washer	1
45	QB-194-CNP45	Bearing Washer	1
46	QB-194-CNP46	Ring	1
47	QB-194-CNP47	Detent Handle	1
48	QB-194-CNP48	Dead Handle Joint	1
49	QB-194-CNP49	Exhaust Cover Holder	1
50	QB-194-CNP50	Ball Bearing (626)	1
51	QB-194-CNP51	Ball Bearing (609)	1
52	QB-194-CNP52	Ball Bearing (6200)	1
53	QB-194-CNP53	Ball Bearing (6004)	1
54	QB-194-CNP54	Needle Roller	1
55	QB-194-CNP55	O Ring	1
56	QB-194-CNT56	Bottom Head Cap Screw (2PCS)	1 SET
57	QB-194-CNP57	Spring Washer	1
58	QB-194-CNT58	Spring Washer (2PCS)	1 SET
59	QB-194-CNP59	Key	1



Air Angle Grinder

Item No : QB-195-85

QB-195L-85

ROLL HANDLE

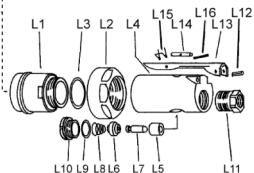

LOCK LEVER HANDLE

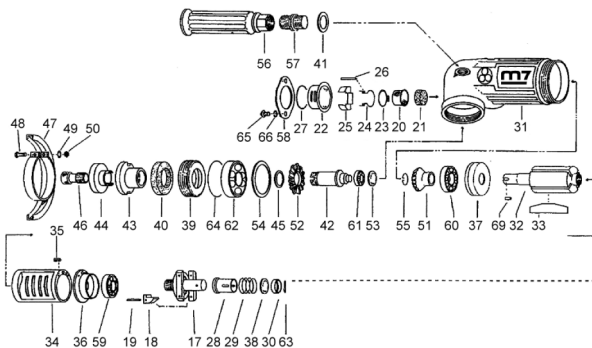

Part List

Item No : QB-195-85
QB-195L-85



No.	Part No.	Description	Q'ty
1	QB-195-85P01	Housing Cover	1
2	QB-195-85P02	Bushing	1
3	QB-195-85P03	Throttle Valve Handle	1
4	QB-195-85P04	Throttle Valve	1
5	QB-195-85P05	Throttle Valve Spring	1
6	QB-195-85P06	Throttle Valve Cover	1
7	QB-195-85P07	Strainer	1
8	QB-195-85P08	Throttle Valve Handle Spring	1
9	QB-195-85P09	Needle Roller	1
10	QB-195-85P10	Strainer	1
11	QB-195-85P11	O Ring	1
12	QB-195-85P12	Cup Nut	1
17	QB-195-85P17	Governor Cage	1
18	QB-195-85T18	Governor Weight (2 PCS)	1 SET
19	QB-195-85T19	Grooved Pin (2 PCS)	1 SET
20	QB-195-85P20	Strainer	1
21	QB-195-85P21	Muffler Cover	1
22	QB-195-85P22	Exhaust Cover	1
23	QB-195-85P23	Muffler Plate	1
24	QB-195-85P24	Muffler Spring	1
25	QB-195-85P25	Muffler Plate Holder	1
26	QB-195-85P26	Spring Pin	1
27	QB-195-85P27	O Ring	1
28	QB-195-85P28	Governor Valve	1
29	QB-195-85P29	Governor Valve Spring	1
30	QB-195-85P30	Governor Valve Spring Holder	1
31	QB-195-85P31	Housing	1
32	QB-195-85P32	Rotor	1
33	QB-195-85T33	Rotor Blade (4 PCS)	1 SET
34	QB-195-85P34	Cylinder	1
35	QB-195-85P35	Spring Pin	1
36	QB-195-85P36	Cylinder Upper Plate	1
37	QB-195-85P37	Cylinder Lower Plate	1
38	QB-195-85P38	Adjusting Washer	1
39	QB-195-85P39	Spindle Bearing Cover	1
40	QB-195-85P40	Felt Ring	1
41	QB-195-85P41	Conical Spring Washer	1
42	QB-195-85P42	Wheel Spindle	1
43	QB-195-85P43	Wheel Flange A	1
44	QB-195-85P44	Wheel Flange B	1

No.	Part No.	Description	Q'ty
45	QB-195-85P45	Wheel Spindle Washer	1
46	QB-195-85P46	Detent Bolt	1
47	QB-195-85P47	Wheel Guard	1
48	QB-195-85P48	Bolt	1
49	QB-195-85P49	Spring Washer	1
50	QB-195-85P50	Nut	1
51	QB-195-85P51	Bevel Pinion	1
52	QB-195-85P52	Bevel Gear	1
53	QB-195-85P53	Bearing Washer	1
54	QB-195-85P54	Bearing Washer	1
55	QB-195-85P55	Ring	1
56	QB-195-85P56	Dead Handle	1
57	QB-195-85P57	Dead Handle Joint	1
58	QB-195-85P58	Exhaust Cover Holder	1
59	QB-195-85P59	Ball Bearing 609MN	1
60	QB-195-85P60	Ball Bearing 6200	1
61	QB-195-85P61	Ball Bearing 626	1
62	QB-195-85P62	Ball Bearing 6004	1
63	QB-195-85P63	Needle Roller	1
64	QB-195-85P64	O Ring	1
65	QB-195-85T65	Bottom Head Cap Screw (2 PCS)	1 SET
66	QB-195-85T66	Spring Washer (2 PCS)	1 SET
67	QB-195-85P67	Key	1
L1	QB-195-85LP01	Housing Cover	1
L2	QB-195-85LP02	Cup Nut	1
L3	QB-195-85LP03	O Ring	1
L4	QB-195-85LP04	Throttle Valve Body	1
L5	QB-195-85LP05	Throttle Valve Rod Bushing	1
L6	QB-195-85LP06	Throttle Valve	1
L7	QB-195-85LP07	Throttle Valve Rod	1
L8	QB-195-85LP08	Throttle Valve Spring	1
L9	QB-195-85LP09	Throttle Valve Cover Packing	1
L10	QB-195-85LP10	Throttle Valve Cover	1
L11	QB-195-85LP11	Inlet	1
L12	QB-195-85LP12	Spring Pin	1
L13	QB-195-85LP13	Throttle Valve Lever	1
L14	QB-195-85LP14	Safety Lock	1
L15	QB-195-85LP15	Safety Lock Spring	1
L16	QB-195-85LP16	Spring Pin	1



Air Angle Grinder

Item No : QB-195-120

QB-195L-120

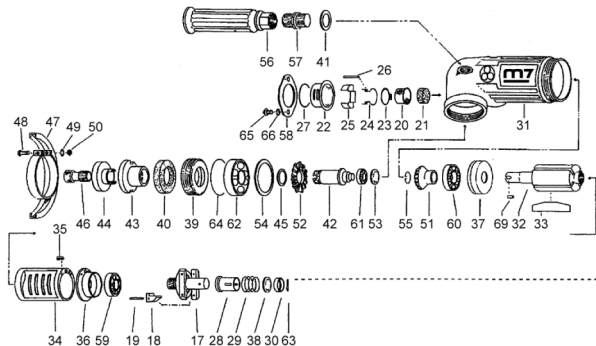

ROLL HANDLE

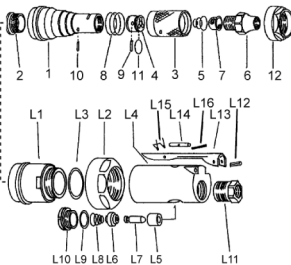

LOCK LEVER HANDLE

Part List

Item No : QB-195L-120
QB-195-120



No.	Part No.	Description	Q'ty
1	QB-195-120P01	Housing Cover	1
2	QB-195-120P02	Bushing	1
3	QB-195-120P03	Throttle Valve Handle	1
4	QB-195-120P04	Throttle Valve	1
5	QB-195-120P05	Throttle Valve Spring	1
6	QB-195-120P06	Throttle Valve Cover	1
7	QB-195-120P07	Strainer	1
8	QB-195-120P08	Throttle Valve Handle Spring	1
9	QB-195-120P09	Needle Roller	1
10	QB-195-120P10	Strainer	1
11	QB-195-120P11	O Ring	1
12	QB-195-120P12	Cup Nut	1
17	QB-195-120P17	Governor Cage	1
18	QB-195-120T18	Governor Weight (2 PCS)	1 SET
19	QB-195-120T19	Grooved Pin (2 PCS)	1 SET
20	QB-195-120P20	Strainer	1
21	QB-195-120P21	Muffler Cover	1
22	QB-195-120P22	Exhaust Cover	1
23	QB-195-120P23	Muffler Plate	1
24	QB-195-120P24	Muffler Spring	1
25	QB-195-120P25	Muffler Plate Holder	1
26	QB-195-120P26	Spring Pin	1
27	QB-195-120P27	O Ring	1
28	QB-195-120P28	Governor Valve	1
29	QB-195-120P29	Governor Valve Spring	1
30	QB-195-120P30	Governor Valve Spring Holder	1
31	QB-195-120P31	Housing	1
32	QB-195-120P32	Rotor	1
33	QB-195-120T33	Rotor Blade (4 PCS)	1 SET
34	QB-195-120P34	Cylinder	1
35	QB-195-120P35	Spring Pin	1
36	QB-195-120P36	Cylinder Upper Plate	1
37	QB-195-120P37	Cylinder Lower Plate	1
38	QB-195-120P38	Adjusting Washer	1
39	QB-195-120P39	Spindle Bearing Cover	1
40	QB-195-120P40	Felt Ring	1
41	QB-195-120P41	Conical Spring Washer	1
42	QB-195-120P42	Wheel Spindle	1
43	QB-195-120P43	Wheel Flange A	1
44	QB-195-120P44	Wheel Flange B	1

No.	Part No.	Description	Q'ty
45	QB-195-120P45	Wheel Spindle Washer	1
46	QB-195-120P46	Detent Bolt	1
47	QB-195-120P47	Wheel Guard	1
48	QB-195-120P48	Bolt	1
49	QB-195-120P49	Spring Washer	1
50	QB-195-120P50	Nut	1
51	QB-195-120P51	Bevel Pinion	1
52	QB-195-120P52	Bevel Gear	1
53	QB-195-120P53	Bearing Washer	1
54	QB-195-120P54	Bearing Washer	1
55	QB-195-120P55	Ring	1
56	QB-195-120P56	Dead Handle	1
57	QB-195-120P57	Dead Handle Joint	1
58	QB-195-120P58	Exhaust Cover Holder	1
59	QB-195-120P59	Ball Bearing 609MN	1
60	QB-195-120P60	Ball Bearing 6200	1
61	QB-195-120P61	Ball Bearing 626	1
62	QB-195-120P62	Ball Bearing 6004	1
63	QB-195-120P63	Needle Roller	1
64	QB-195-120P64	O Ring	1
65	QB-195-120T65	Bottom Head Cap Screw (2 PCS)	1 SET
66	QB-195-120T66	Spring Washer (2 PCS)	1 SET
67	QB-195-120P67	Key	1
L1	QB-195-120LP01	Housing Cover	1
L2	QB-195-120LP02	Cup Nut	1
L3	QB-195-120LP03	O Ring	1
L4	QB-195-120LP04	Throttle Valve Body	1
L5	QB-195-120LP05	Throttle Valve Rod Bushing	1
L6	QB-195-120LP06	Throttle Valve	1
L7	QB-195-120LP07	Throttle Valve Rod	1
L8	QB-195-120LP08	Throttle Valve Spring	1
L9	QB-195-120LP09	Throttle Valve Cover Packing	1
L10	QB-195-120LP10	Throttle Valve Cover	1
L11	QB-195-120LP11	Inlet	1
L12	QB-195-120LP12	Spring Pin	1
L13	QB-195-120LP13	Throttle Valve Lever	1
L14	QB-195-120LP14	Safety Lock	1
L15	QB-195-120LP15	Safety Lock Spring	1
L16	QB-195-120LP16	Spring Pin	1



Air Angle Grinder

Item No : QB-195-CN

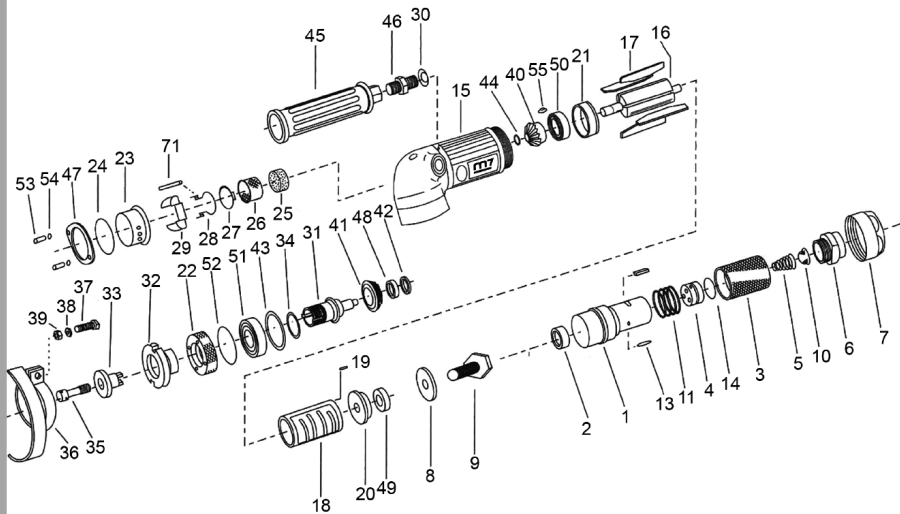

Part List

Roll Type Throttle
Item No : QB-195-CN



No.	Part No.	Description	Q'ty
1	QB-195-CNP01	Housing Cover	1
2	QB-195-CNP02	Bushing	1
3	QB-195-CNP03	Throttle Valve Handle	1
4	QB-195-CNP04	Throttle Valve	1
5	QB-195-CNP05	Throttle Valve Spring	1
6	QB-195-CNP06	Throttle Valve Cover	1
7	QB-195-CNP07	Cup Nut	1
8	QB-195-CNP08	Top plate Washer	1
9	QB-195-CNP09	Lock Screw	1
10	QB-195-CNP10	Strainer	1
11	QB-195-CNP11	Throttle Valve Handle Spring	1
12	QB-195-CNP12	Needle Roller 3*12	1
13	QB-195-CNP13	Needle Roller 4*15	1
14	QB-195-CNP14	O Ring	1
15	QB-195-CNP15	Housing	1
16	QB-195-CNP16	Rotor	1
17	QB-195-CNT17	Rotor Blade (4PCS)	1 SET
18	QB-195-CNP18	Cylinder	1
19	QB-195-CNP19	Spring Pin 2*6	1
20	QB-195-CNP20	Cylinder Upper Plate	1
21	QB-195-CNP21	Cylinder Lower Plate	1
22	QB-195-CNP22	Spindle Bearing Cover	1
23	QB-195-CNP23	Exhaust Cover	1
24	QB-195-CNP24	O Ring	1
25	QB-195-CNP25	Muffler Pad	1
26	QB-195-CNP26	Strainer	1
27	QB-195-CNP27	Muffler Plate	1
28	QB-195-CNP28	Muffler Spring	1
29	QB-195-CNP29	Muffler Plate Holder	1
30	QB-195-CNP30	Conical Spring Washer	1
31	QB-195-CNP31	Wheel Spindle	1
32	QB-195-CNP32	Wheel Flange A	1
33	QB-195-CNP33	Wheel Flange B	1
34	QB-195-CNP34	O ring	1
35	QB-195-CNP35	Detent Bolt	1
36	QB-195-CNP36	Wheel Guard	1

No.	Part No.	Description	Q'ty
37	QB-195-CNP37	Hexagon Bolt	1
38	QB-195-CNP38	Spring Washer	1
39	QB-195-CNP39	Nut	1
40	QB-195-CNP40	Bevel Pinion	1
41	QB-195-CNP41	Bevel Gear	1
42	QB-195-CNP42	Bearing Washer	1
43	QB-195-CNP43	Bearing Washer	1
44	QB-195-CNP44	Ring	1
45	QB-195-CNP45	Dead Handle	1
46	QB-195-CNP46	Dead Handle Joint	1
47	QB-195-CNP47	Exhaust Cover Holder	1
48	QB-195-CNP48	Ball Bearing (626)	1
49	QB-195-CNP49	Ball Bearing (609)	1
50	QB-195-CNP50	Ball Bearing (6200)	1
51	QB-195-CNP51	Ball Bearing (6004)	1
52	QB-195-CNP52	O Ring	1
53	QB-195-CNT53	Cap Screw (2PCS)	1 SET
54	QB-195-CNT54	Spring Washer (2PCS)	1 SET
55	QB-195-CNP55	Key	1
56	QB-195-CNP56	Housing Cover	1
57	QB-195-CNP57	Handle	1
58	QB-195-CNP58	Throttle Valve	1
59	QB-195-CNP59	Throttle Pin	1
60	QB-195-CNP60	Throttle Valve Spring	1
61	QB-195-CNP61	T.V. Cover Packing	1
62	QB-195-CNP62	Throttle Valve Cover	1
63	QB-195-CNP63	Lever	1
64	QB-195-CNP64	Throttle Valve Rod Bushing	1
65	QB-195-CNP65	Inlet Bushing	1
66	QB-195-CNP66	Lock Key	1
67	QB-195-CNP67	Lock Spring	1
68	QB-195-CNP68	Spring Pin	1
69	QB-195-CNP69	Spring Pin	1
70	QB-195-CNP70	O Ring	1
71	QB-195-CNP71	Pin	1

Part List

Lever Type Throttle
Item No : QB-623



No.	Part No.	Description	Q'ty
1	QB-623P01	Valve Screw	1
2	QB-623T02	O-Ring	1
3	QB-623P03	O-Ring	1
4	QB-623P04	Air Regulator	1
5	QB-623P05	Spring	1
6	QB-623P06	O-Ring	1
7	QB-623P07	Throttle Valve	1
8	QB-623P08	O-Ring	1
9	QB-623P09	Valve Bushing	1
10	QB-623P10	Air Inlet Bushing	1
11	QB-623P11	Exhaust Deflector	1
12	QB-623P12	Throttle Lever	1
13	QB-623P13	Throttle Lever Pin	1
14	QB-623P14	Motor Housing	1
15	QB-623P15	Rear End Ball Bearing	1
16	QB-623P16	Rear End Plate	1
17	QB-623P17	Cylinder	1
18	QB-623P18	Spring Pin	1
19	QB-623T19	Rotor Blade (5 pcs)	SET
20	QB-623P20	Rotor	1

No.	Part No.	Description	Q'ty
21	QB-623P21	Rotor Collar	1
22	QB-623P22	Front End Plate	1
23	QB-623P23	Front End Ball Bearing	1
24	QB-623P24	Pinion Gear	1
25	QB-623P25	Lock Nut	1
26	QB-623P26	Housing Cap	1
27	QB-623P27	Angle Head Housing	1
28	QB-623P28	Ball Bearing	1
29	QB-623P29	Spindle Gear	1
30	QB-623P30	Ball Bearing	1
31	QB-623P31	Clamp Nut	1
32	QB-623P32	Cover	1
33	QB-623T33	Set Screw (2 pcs)	1 SET
34	QB-623P34	Spindle	1
35	QB-623P35	Woodruff Key 2*8	1
36	QB-623P36	Spindle	1
37	QB-623P37	Washer	1
38	QB-623P38	Flat Screw	1
39	QB-623P39	14mm Spanner	1
40	QB-623P40	4mm Allen Key	1



Air Straight Grinder

Item No : QB-2925 / QB-2925L

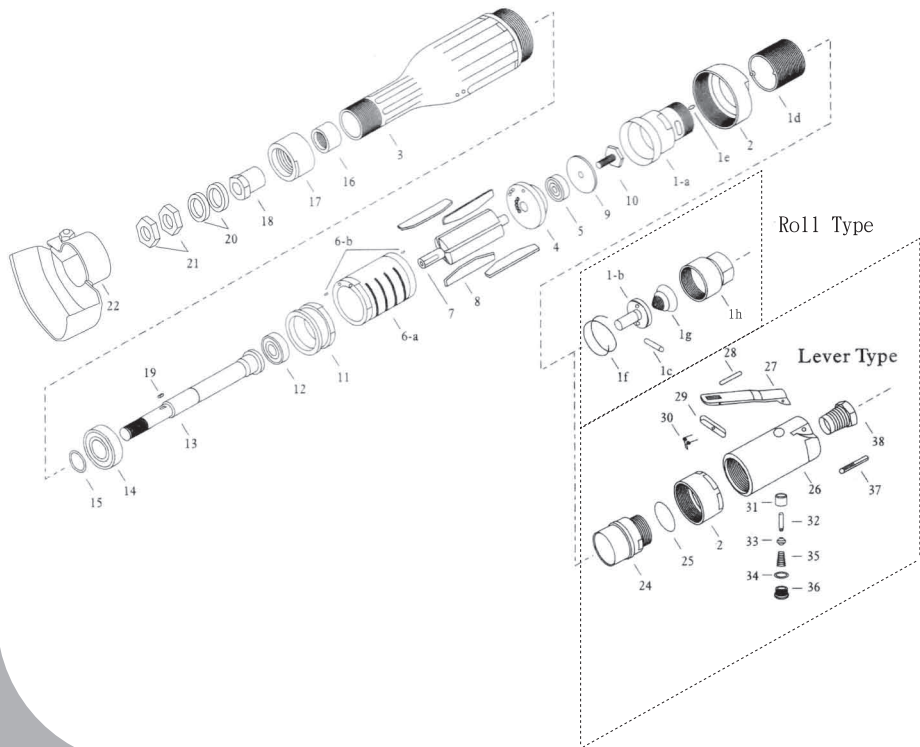

Part List

Item No : QB-2925
QB-2925L



NO.	PART NO.	DESCRIPTION	Q'TY
1	QB-2925P01	Handle C.P.	1
1a	QB-2925P01A	Handle	1
1b	QB-2925P01B	Throttle Valve	1
1c	QB-2925P01C	Throttle Valve pin	1
1d	QB-2925P01D	Grip	1
1e	QB-2925P01E	Spring Pin (2*6)	1
1f	QB-2925P01F	Throttle Valve Handle Spring	1
1g	QB-2925P01G	Throttle Spring	1
1h	QB-2925P01H	Inlet Bushing	1
2	QB-2925LP02	Lock Nut	1
3	QB-2925P03	Rotor Case	1
4	QB-2925P04	Top Plate	1
5	QB-2925P05	Ball Bushing 608	1
6	QB-2925P06	Cylinder C.P.	1
6A	QB-2925P06A	Cylinder	1
6B	QB-2925P06B	Cylinder Pin	1
7	QB-2925P07	Rotor	1
8	QB-2925T08	Vane (4 pcs)	1 SET
9	QB-2925P09	Top Plate Washer	1
10	QB-2925P10	Lock Screw	1
11	QB-2925P11	Bottom Plate	1
12	QB-2925P12	Ball Bearing 629	1
13	QB-2925P13	Stone Spindle	1
14	QB-2925P14	Ball Bearing 6002	1

NO.	PART NO.	DESCRIPTION	Q'TY
15	QB-2925P15	Snap Ring	1
16	QB-2925P16	Needle Bearing 1220	1
17	QB-2925P17	Spindle Case Nut	1
18	QB-2925P18	Stone Frange	1
19	QB-2925P19	Key	1
20	QB-2925T20	Collet Washer (2 pcs)	1 SET
21	QB-2925T21	Collet Nut (2 pcs)	1 SET
22	QB-2925P22	Wheel Guard	1
24	QB-2925LP24	Housing Cover	1
25	QB-2925LP25	O ring	1
26	QB-2925LP26	Handle	1
27	QB-2925LP27	Lever	1
28	QB-2925LP28	Spring Pin	1
29	QB-2925LP29	Lock key	1
30	QB-2925LP30	Lock Spring	1
31	QB-2925LP31	Throttle Bushing	1
32	QB-2925LP32	Pin	1
33	QB-2925LP33	Throttle Valve	1
34	QB-2925LP34	T.V.cover Packing	1
35	QB-2925LP35	Throttle Valve Spring	1
36	QB-2925LP36	Throttle Valve Cover	1
37	QB-2925LP37	Spring Pin	1
38	QB-2925LP38	Inlet Bushing	1

Warranty Card

Manufacturer's limited warranty

Mighty Seven International CO., LTD. offers limited warranty to the products manufactured by **Mighty Seven** and sold by its worldwide authorized dealers. The limited warranty only applies to products that are defective in material and workmanship and does not apply to products which have been abused, misused, modified, or repaired by someone other than **Mighty Seven** or its authorized service representatives. If there is a defective product of **Mighty Seven**, please send it prepaid to the dealer where it was purchased from along with address and contact information. Repairs or replacements are warranted as described above; otherwise, the service of repairs or replacements will be charged.

Please Keep This card For Warranty

Date of Purchase :	Model No. :
Warranty Expiration Date :	Serial No. :
Distributor Stamp	
	



For Distributor

Warranty Card

Date of Purchase :	Model No. :
Warranty Expiration Date :	Serial No. :
Name :	
Company Name :	
Address :	
Tel. :	Fax. :
E-mail :	
Type of Business :	
<input type="checkbox"/> Agriculture	<input type="checkbox"/> Paint & Body Repair
<input type="checkbox"/> General Auto Repair	<input type="checkbox"/> Public Work/Gov. Utilities
<input type="checkbox"/> Tire	<input type="checkbox"/> Factory
<input type="checkbox"/> Truck Maintenance/Repair	<input type="checkbox"/> Home Use
<input type="checkbox"/> Car Maker	<input type="checkbox"/> Other _____
Specification of compressor used :	
Horsepower :	Tank Size (liter/gal) :
<input type="checkbox"/> 5 <input type="checkbox"/> 7,5 <input type="checkbox"/> 10 <input type="checkbox"/> 15+	<input type="checkbox"/> 75,7(20) <input type="checkbox"/> 227,1(60) <input type="checkbox"/> 302,8(80) <input type="checkbox"/> 454,2(120)
<input type="checkbox"/> other _____	<input type="checkbox"/> other _____

Formulaire de garantie

Garantie fabricant

Mighty Seven International CO., LTD offre la garantie fabricant aux produits fabriqués par **Mighty Seven** et vendus par ses distributeurs agréés dans le monde entier. La garantie limitée s'applique seulement aux produits qui sont défectueux et ne s'applique pas aux produits qui ont été mal utilisés, perdus, modifiés ou réparés par quelqu'un d'autre que **Mighty Seven** ou ses services techniques. S'il y a un produit défectueux de **Mighty Seven**, envoyez-le au distributeur où il a été acheté, avec l'adresse et les coordonnées du propriétaire. La réparation ou les remplacements de pièces sont garantis comme décrit ci-dessus; sinon, le service technique facturera la réparation au propriétaire du produit.

Remplir le formulaire de garantie

Date d'achat du produit:	Modèle N°:
Date d'expiration de la garantie:	N° de série:
Tampon du distributeur	
	



Formulaire de garantie

Date d'achat du produit:	Modèle N°:
Date d'expiration de la garantie:	N° de série:
Nom:	
Nom de la société:	
Adresse:	
Tel. :	Fax.:
E-mail:	
Type d'activité: <input type="checkbox"/> Agricole <input type="checkbox"/> Réparations automobile <input type="checkbox"/> Pneumatiques <input type="checkbox"/> Maintenances et réparations poids lourd <input type="checkbox"/> Fabricant automobile <input type="checkbox"/> Carrosserie <input type="checkbox"/> Travaux publics <input type="checkbox"/> Industrie <input type="checkbox"/> Particulier <input type="checkbox"/> Autre _____	
Compresseur utilisé: Puissance CV: <input type="checkbox"/> 5 <input type="checkbox"/> 7,5 <input type="checkbox"/> 10 <input type="checkbox"/> 15+ <input type="checkbox"/> Autre _____	
Taille de la cuve (Litre): <input type="checkbox"/> 75,7 <input type="checkbox"/> 227,1 <input type="checkbox"/> 302,8 <input type="checkbox"/> 454,2 <input type="checkbox"/> Autre _____	

Garantiekarte

Herstellergarantie

Mighty Seven International CO., LTD. bietet Kunden die Garantie mit gewisser Beschränkung für alle Produkte, die aus eigener Herstellung stammen und von **Mighty Sevens** weltweit autorisierten Fachhändlern gekauft worden sind. Garantieansprüche können nur gewährt werden, wenn der Mangel oder Schaden nachweislich auf unsachgemäße Herstellung oder die Verwendung fehlerhafter Materialien zurückzuführen ist. **Mighty Seven** haftet nicht für Beanstandungen der Werkzeuge, die auf unsachgemäße Handhabung, sowie zu hohen Betriebsdruck, oder der Verwendung von falschen Zubehörteilen zurückzuführen sind. Mighty Seven schuldet auch nicht für Ausfälle, die die mangelhafte Wartung und Überbeanspruchung der Werkzeuge nachweisen.

Garantieansprüche können nur dem Hersteller oder den autorisierten Fachhändlern gegenüber schriftlich geltend gemacht werden. Im Fall einer Reklamation sollen die defekten Teile mit der Kontaktanschrift des Absenders zurück an die Verkaufsstelle gesendet werden. Für die Werkzeuge, an denen eigenhändige Reparaturversuche bereits vorgenommen wurde, entfällt jeglicher Garantieanspruch.

Bitte diese Garantiekarte aufbewahren!

Einkaufsdatum:	Model-Nr.:
Garantieablaufdatum:	Serien-Nr.:
Ihre Mighty Seven Fachhändler	
	



Garantiekarte

Einkaufsdatum:	Model-Nr.:
Garantieablaufdatum:	Serien-Nr.:
Name:	
Firmenname:	
Adresse:	
Tel.:	Fax.:
Email:	
Branche: <input type="checkbox"/> Agrarindustrie: <input type="checkbox"/> Auto-Karosserie und Lackierer <input type="checkbox"/> Allg. KFZ-Reparaturdienst <input type="checkbox"/> für Öffentlichkeitarbeit <input type="checkbox"/> Reifenservice <input type="checkbox"/> Produktion <input type="checkbox"/> Nutzfahrzeug-LKW-Service <input type="checkbox"/> Heimwerk <input type="checkbox"/> Autohersteller <input type="checkbox"/> Sonstiges _____	
Spezifikation des verwendeten Kompressors: Psi (bar): <input type="checkbox"/> 5 <input type="checkbox"/> 7,5 <input type="checkbox"/> 10 <input type="checkbox"/> 15+ <input type="checkbox"/> Sonstiges _____	
Luftbehälter (Liter): <input type="checkbox"/> 75,7 <input type="checkbox"/> 227,1 <input type="checkbox"/> 302,8 <input type="checkbox"/> 454,2 <input type="checkbox"/> Sonstiges _____	

Tarjeta de Garantía

Garantía Limitada del Fabricante

Mighty Seven International CO., LTD. ofrece una garantía limitada a los productos fabricados por **Mighty Seven** y vendidos por sus agentes autorizados a nivel internacional. La garantía limitada sólo aplica a defectos de material o manufactura y no aplica a productos que hayan sido abusados, malusados, modificados o reparados por terceros ajenos a **Mighty Seven** o sus representantes de servicio autorizados. Si hubiera un defecto en un producto de Mighty Seven, por favor enviarlo prepagado al lugar donde fue comprado adjuntando su dirección e información de contacto. Las reparaciones o reemplazos son garantizados en los casos arriba explicados; de lo contrario las reparaciones o reemplazos tendrán un costo que deberá ser pagado por el cliente.

Por favor conservar esta tarjeta para Garantía

Fecha de Compra :	Modelo No. :
Fecha de fin de Garantía :	No. de Serie :
Sello del Distribuidor	
	



Tarjeta de Garantía

Fecha de Compra :	Modelo No. :
Fecha de fin de Garantía :	No. de Serie :
Nombre :	
Nombre de la Empresa :	
Dirección :	
Tel.:	Fax.:
Email:	
Tipo de Negocio : <input type="checkbox"/> Agricultura <input type="checkbox"/> Reparación Gral. Autos <input type="checkbox"/> Llantas <input type="checkbox"/> Reparación/mant.camiones <input type="checkbox"/> Fabricante de Autos <input type="checkbox"/> Pintura y reparación carrocería <input type="checkbox"/> Trabajo público / Gobierno <input type="checkbox"/> Fábrica <input type="checkbox"/> Uso Casero <input type="checkbox"/> Otros _____	
Especificaciones de la compresora usada: Potencia (HP) : <input type="checkbox"/> 5 <input type="checkbox"/> 7,5 <input type="checkbox"/> 10 <input type="checkbox"/> 15+ <input type="checkbox"/> Otros _____	
Tamaño de tanque (litro) : <input type="checkbox"/> 75,7 <input type="checkbox"/> 227,1 <input type="checkbox"/> 302,8 <input type="checkbox"/> 454,2 <input type="checkbox"/> Otros _____	

Cartão de garantia

Garantia limitada de fabricante

A **Mighty Mighty Seven International CO., LTD** oferece garantia limitada aos produtos por ela fabricados e vendidos globalmente por seus distribuidores autorizados. A garantia limitada aplica-se somente aos produtos que apresentarem defeitos de material ou manufatura, não cobrindo, portanto, produtos que forem usados incorretamente, danificados, modificados ou reparados por outros que não a própria **Mighty Seven** International ou seus distribuidores autorizados. Se houver um produto **Mighty Seven** defeituoso, por favor, envie-o com frete pago para o distribuidor onde ele foi comprado, incluindo no pacote informações para contato e endereço para devolução. Reparos ou trocas em garantia serão oferecidos conforme condições acima descritas. Nos demais casos peças e mão-de-obra serão cobrados.

Por favor, guarde este cartão para fins de garantia.

Data da compra:	Modelo:
Garantia válida até:	Nº de série:
Carimbo do distribuidor	
	



Cartão de garantia

Data da compra:	Modelo:										
Garantia válida até:	Nº de série:										
Nome:											
Nome da empresa:											
Endereço:											
Tel. :	Fax.:										
E-mail:											
Ramo de negócio: <table style="width: 100%; border: none;"> <tr> <td><input type="checkbox"/> Agricultura</td> <td><input type="checkbox"/> Funilaria e pintura</td> </tr> <tr> <td><input type="checkbox"/> Reparação automotiva</td> <td><input type="checkbox"/> Órgão público</td> </tr> <tr> <td><input type="checkbox"/> Troca de pneus</td> <td><input type="checkbox"/> Indústria</td> </tr> <tr> <td><input type="checkbox"/> Reparação diesel</td> <td><input type="checkbox"/> Uso doméstico</td> </tr> <tr> <td><input type="checkbox"/> Montadoras</td> <td><input type="checkbox"/> Outras _____</td> </tr> </table>		<input type="checkbox"/> Agricultura	<input type="checkbox"/> Funilaria e pintura	<input type="checkbox"/> Reparação automotiva	<input type="checkbox"/> Órgão público	<input type="checkbox"/> Troca de pneus	<input type="checkbox"/> Indústria	<input type="checkbox"/> Reparação diesel	<input type="checkbox"/> Uso doméstico	<input type="checkbox"/> Montadoras	<input type="checkbox"/> Outras _____
<input type="checkbox"/> Agricultura	<input type="checkbox"/> Funilaria e pintura										
<input type="checkbox"/> Reparação automotiva	<input type="checkbox"/> Órgão público										
<input type="checkbox"/> Troca de pneus	<input type="checkbox"/> Indústria										
<input type="checkbox"/> Reparação diesel	<input type="checkbox"/> Uso doméstico										
<input type="checkbox"/> Montadoras	<input type="checkbox"/> Outras _____										
Especificações do compressor usado: <table style="width: 100%; border: none;"> <tr> <td> Potência (hp): <input type="checkbox"/> 5 <input type="checkbox"/> 7,5 <input type="checkbox"/> 10 <input type="checkbox"/> 15+ <input type="checkbox"/> Outras _____ </td> <td> Volume do Reservatório (litros): <input type="checkbox"/> 75,7 <input type="checkbox"/> 227,1 <input type="checkbox"/> 302,8 <input type="checkbox"/> 454,2 <input type="checkbox"/> Outras _____ </td> </tr> </table>		Potência (hp): <input type="checkbox"/> 5 <input type="checkbox"/> 7,5 <input type="checkbox"/> 10 <input type="checkbox"/> 15+ <input type="checkbox"/> Outras _____	Volume do Reservatório (litros): <input type="checkbox"/> 75,7 <input type="checkbox"/> 227,1 <input type="checkbox"/> 302,8 <input type="checkbox"/> 454,2 <input type="checkbox"/> Outras _____								
Potência (hp): <input type="checkbox"/> 5 <input type="checkbox"/> 7,5 <input type="checkbox"/> 10 <input type="checkbox"/> 15+ <input type="checkbox"/> Outras _____	Volume do Reservatório (litros): <input type="checkbox"/> 75,7 <input type="checkbox"/> 227,1 <input type="checkbox"/> 302,8 <input type="checkbox"/> 454,2 <input type="checkbox"/> Outras _____										

Karta gwarancyjna

Warunki gwarancji producenta

Mighty Seven International CO., LTD oferuje ograniczoną gwarancję do produktów wyprodukowanych przez **Mighty Seven** i sprzedanych przez jego autoryzowanych dealerów. Niniejszą gwarancją objęte są usterki produktu spowodowane wadami produkcyjnymi i wadami materiałowymi.

Gwarancją nie jest objęte wadliwe działanie lub uszkodzenia spowodowane niewłaściwym użytkowaniem lub użytkowaniem produktu niezgodnie z przeznaczeniem, instrukcją obsługi lub przepisami bezpieczeństwa i nie odnosi się do produktów zmodyfikowanych, albo naprawionych przez kogoś innego niż **Mighty Seven** lub autoryzowany serwis .

Wadliwy produkt **Mighty Seven** , proszę wysłać na koszt nadawcy do dealera, gdzie produkt został nabyty , wraz z adresem zwrotnym , informacją o usterce i kontaktem.

W przypadku nie spełnienia warunków gwarancji naprawa zostanie wykonana odpłatnie.

Proszę zatrzymać tę kartę gwarancyjną .

Data sprzedaży :	Model nr :
Termin upływu gwarancji :	Seryjny nr :
Pieczętka sprzedawcy	
	



Karta gwarancyjna

Data sprzedaży :	Model nr :
Termin upływu gwarancji :	Seryjny nr :
Name:	
Imię i Nazwisko /nazwa firmy :	
Adres :	
Tel. :	Faks. :
E-mail :	
Rolnictwo: <input type="checkbox"/> Blacharstwo samochodowe <input type="checkbox"/> Mechanika samochodowa <input type="checkbox"/> Wulkanizacja <input type="checkbox"/> Warsztat samochodów ciężarowych <input type="checkbox"/> Użytek domowy	
<input type="checkbox"/> Produkcja <input type="checkbox"/> Inne _____	
Specyfikacja kompresora: Moc: <input type="checkbox"/> 5 <input type="checkbox"/> 7,5 <input type="checkbox"/> 10 <input type="checkbox"/> 15+ <input type="checkbox"/> inny _____	
Rozmiar zbiornika(L): <input type="checkbox"/> 75,7 <input type="checkbox"/> 227,1 <input type="checkbox"/> 302,8 <input type="checkbox"/> 454,2 <input type="checkbox"/> inny _____	

保固卡

镁迪企业股份有限公司提供有限的产品保固,范围仅限定由镁迪公司所生产制造,并透过其全球各大合格经销商推广销售,若因材质因素或制程瑕疵而导致缺陷之产品。反之,若因不当使用、误用、自行拆卸、修改,或非经由镁迪所授权之服务人员维修,而造成产品故障或损伤,则不在保固范围之列。

如果发现镁迪公司产品在保固范围内有上述缺陷,请将产品连同地址、联络信息、购买发票及运费等,送回原购买的经销商处进行维修。保固范围以外的所有维修或零件更换等需求,经销商或服务据点得依实际维修内容收取相关费用。

请妥善保存此保固卡。

购买日:	产品型号:
保固有效期:	产品序号:
经销商章	
	



保固卡

销售日:	产品型号:
保固有效期:	产品序号:
姓名:	
公司名称:	
地址:	
电话:	传真:
电邮:	
通路别: <input type="checkbox"/> 农业机械 <input type="checkbox"/> 一般汽车维修 <input type="checkbox"/> 轮胎 <input type="checkbox"/> 卡车维修 <input type="checkbox"/> 汽车制造 <input type="checkbox"/> 车体烤漆&维修 <input type="checkbox"/> 公共工程/ 政府公共事业 <input type="checkbox"/> 工厂 <input type="checkbox"/> 居家修缮 <input type="checkbox"/> 其它 _____	
所使用的空压机规格:	
马力 <input type="checkbox"/> 5 <input type="checkbox"/> 7.5 <input type="checkbox"/> 10 <input type="checkbox"/> 15+ <input type="checkbox"/> 其它 _____	贮气槽 (gal): <input type="checkbox"/> 20 <input type="checkbox"/> 60 <input type="checkbox"/> 80 <input type="checkbox"/> 120 <input type="checkbox"/> 其它 _____

بطاقة ضمان

شهادة ضمان المصنع المحدودة

محدودة على المنتجات التي تصنعها شركة مايتي سيفين و التي تباع ان شركة مايتي سيفين الدولية (ال . ال . سى) تقدم شهادة ضمان المحدود الا على المنتجات المعيبة فى خاماتها و تصنيعها حيث لا . بمعرفة موزعيها المعتمدين حول العالم . هذا و لا يسرى الضمان اصلحها لادى اى طرف عدا مايتي سيفين او ممثليها المفوضين ينطبق على المنتجات المساء تشغيلها أو التي تم تعديلها أو التي تم بالصيانة .
الذى الموزع المختص الذى أشترى منه مع عدوانكم و بيانات هذا و نرجو فى حالة تواجد منتج معيب من مايتي سيفين أن ترسلوه كالموصف عليه و فيما عدا ذلك فان خدمة الإصلاحات أو الاستبدال الاتصال طرفكم . و أما الإصلاحات أو الاستبدال فتحت ضد مان تتم المحاسبة عليها .

هذا و نرجو الاحتفاظ بهذه البطاقة من أجل الضمان :

تاريخ الشراء :	موديل رقم :
تاريخ انتهاء الضمان :	مسلسل رقم :
<h2>ختم الموزع</h2> 	



بطاقة ضمان

تاريخ الشراء :	موديل رقم :
تاريخ انتهاء الضمان :	مسلسل رقم :
الاسم :	
اسم الشركة :	
العنوان :	
رقم التليفون :	
عنوان البريد الالكتروني (ايميل) :	
نوعية النشاط : <input type="checkbox"/> الات زراعية <input type="checkbox"/> اصلاحات عامة للسيارة <input type="checkbox"/> الاطارات <input type="checkbox"/> صيانة و اصلاح مركبات النقل <input type="checkbox"/> صناعة السيارات <input type="checkbox"/> اصلاح البن (سمكرة) دو <input type="checkbox"/> مرافق الأشغال العامة و الحكومية <input type="checkbox"/> لمصانع <input type="checkbox"/> لاستخدامات المنزلية <input type="checkbox"/> أنشطة أخرى	
مواصفات ضاغط الهواء (الكمبيوتر) المستخدم القدرات بالحصان : (فما فوق) قدرات أخرى <input type="checkbox"/> 5 <input type="checkbox"/> 7,5 <input type="checkbox"/> 10 <input type="checkbox"/> 15+	
حجم التانك (بالتر) : (فما فوق) قدرات أخرى <input type="checkbox"/> 75,7 <input type="checkbox"/> 227,1 <input type="checkbox"/> 302,8 <input type="checkbox"/> 454,2	